

## Panel feed-through terminal block - HDFKV 50-VP - 0708580

Please be informed that the data shown in this PDF Document is generated from our Online Catalog. Please find the complete data in the user's documentation. Our General Terms of Use for Downloads are valid (<http://phoenixcontact.com/download>)

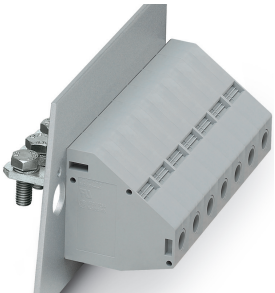

The figure shows a 7-position version

Panel feed-through terminal block, connection method: Screw connection with tension sleeve, Cable lug connection, number of positions: 1, load current: 150 A, cross section: 16 mm<sup>2</sup> - 50 mm<sup>2</sup>, connection direction of the conductor to plug-in direction: -90 °, width: 18.8 mm, color: gray

### Your advantages

- ✓ Well-known connection principle allows worldwide use
- ✓ Low temperature rise, thanks to maximum contact force
- ✓ Tool-free snap-in principle enables easy mounting on the device panel
- ✓ Automatic panel thickness compensation enables universal use
- ✓ Reliable seal even with low-viscosity molding compounds

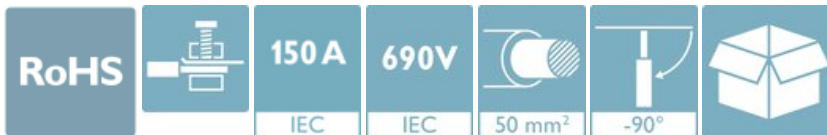

### Key Commercial Data

Packing unit	1 pc
Minimum order quantity	10 pc
GTIN	
GTIN	4017918004699
Weight per Piece (excluding packing)	99.400 g
Custom tariff number	85369010
Country of origin	Greece

### Technical data

#### Item properties

Brief article description	Panel feed-through terminal block
Range of articles	HDFKV 50-VP

## Panel feed-through terminal block - HDFKV 50-VP - 0708580

### Technical data

#### Item properties

Pitch	18.8 mm
Number of positions	1
Number of connections	2
Number of potentials	1

#### Electrical parameters

Nominal current	150 A
Nom. voltage	690 V
Maximum load current	150 A (with 50 mm <sup>2</sup> conductor cross section)
Rated voltage (III/3)	690 V
Rated surge voltage (III/3)	8 kV

#### Connection capacity, external

Connection method	Screw connection with tension sleeve
Connection direction of the conductor to plug-in direction	-90 °
Conductor cross section solid	16 mm <sup>2</sup> ... 50 mm <sup>2</sup>
Conductor cross section flexible	16 mm <sup>2</sup> ... 50 mm <sup>2</sup>
Conductor cross section flexible, with ferrule without plastic sleeve	10 mm <sup>2</sup> ... 50 mm <sup>2</sup>
Conductor cross section, flexible, with ferrule, with plastic sleeve	10 mm <sup>2</sup> ... 50 mm <sup>2</sup>
2 conductors with same cross section, solid	6 mm <sup>2</sup> ... 16 mm <sup>2</sup>
2 conductors with same cross section, flexible	10 mm <sup>2</sup> ... 16 mm <sup>2</sup>
2 conductors with same cross section, flexible, with ferrule without plastic sleeve	6 mm <sup>2</sup> ... 16 mm <sup>2</sup>
2 conductors with the same cross section, flexible, with TWIN ferrule with plastic sleeve	6 mm <sup>2</sup> ... 10 mm <sup>2</sup>
Internal cylindrical gage	B10
Stripping length	24 mm
Torque	6 Nm ... 8 Nm

#### Connection capacity, internal

Connection method	Cable lug connection
Connection direction of the conductor to plug-in direction	0 °
Cable lug connection according to standard	M8 12 Nm 15 Nm

#### Material data - contact

Note	WEEE/RoHS-compliant, free of whiskers according to IEC 60068-2-82/ JEDEC JESD 201
Contact material	Cu alloy
Surface characteristics	tin-plated

#### Material data - housing

# Panel feed-through terminal block - HDFKV 50-VP - 0708580

## Technical data

### Material data - housing

Housing color	gray (7042)
Insulating material	PA
Insulating material group	I
CTI according to IEC 60112	600
Flammability rating according to UL 94	V0
Glow wire flammability index GWFI according to EN 60695-2-12	850
Glow wire ignition temperature GWIT according to EN 60695-2-13	775
Temperature for the ball pressure test according to EN 60695-10-2	125 °C

### Dimensions for the product

Caption	Schematische Abbildung - weitere Details siehe Produktfamilienzeichnung im Download Center
Length [ l ]	90 mm
Width [ w ]	18.8 mm
Height [ h ]	56 mm
Pitch	18.8 mm

### Dimensions for mounting cutout

Plate thickness	1 mm ... 6 mm
-----------------	---------------

### Packaging information

Type of packaging	packed in cardboard
Pieces per package	10
Denomination packing units	Pcs.

### Electrical tests

Rated current	150 A
Conductor cross section	50 mm <sup>2</sup>

### Air clearances and creepage distances

Minimum clearance - inhomogeneous field (III/3)	8 mm
Minimum creepage distance value (III/3)	8 mm

### Standards and Regulations

Connection in acc. with standard	CSA
	IEC 60947-7-1
Flammability rating according to UL 94	V0
Safety note	<ul style="list-style-type: none"> <li>Only electrically qualified personnel may install and operate the product. To recognize and prevent danger, the qualified personnel must be familiar with the basics of electrical engineering.</li> </ul>

# Panel feed-through terminal block - HDFKV 50-VP - 0708580

## Technical data

### Standards and Regulations

	<ul style="list-style-type: none"> <li>Observe the technical data provided here and refer to the documents listed under "Downloads". The download area contains important information, such as installation notes, technical drawings, and 3D data.</li> </ul>
	<ul style="list-style-type: none"> <li>The cable entry funnel is not safe to touch. Never connect or disconnect the terminal when it is energized. Take appropriate steps to ensure touch protection.</li> </ul>
	<ul style="list-style-type: none"> <li>To maintain the nominal voltage, align the cable lugs straight and centered, and cast the terminals on the inside.</li> </ul>
	<ul style="list-style-type: none"> <li># There is no electrical contact to the housing. Make sure that protective grounding is provided for green/yellow color variants and articles marked with PE.</li> </ul>

### Environmental Product Compliance

China RoHS	Environmentally friendly use period: unlimited = EFUP-e
	No hazardous substances above threshold values

## Drawings

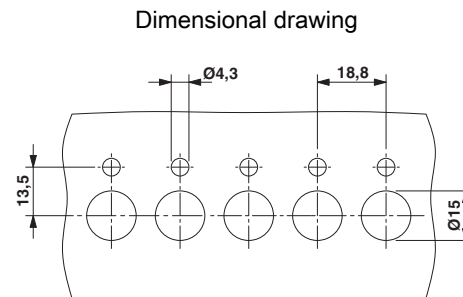
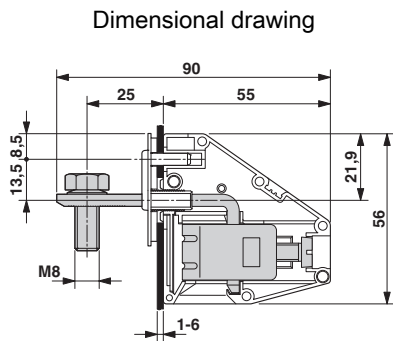

## Classifications

eCl@ss

eCl@ss 10.0.1	27141134
eCl@ss 11.0	27141134
eCl@ss 4.0	27141100
eCl@ss 4.1	27141100
eCl@ss 5.0	27141100
eCl@ss 5.1	27141100
eCl@ss 6.0	27141100
eCl@ss 7.0	27141134
eCl@ss 9.0	27141134

# Panel feed-through terminal block - HDFKV 50-VP - 0708580

## Classifications

### ETIM

ETIM 2.0	EC001283
ETIM 3.0	EC001283
ETIM 4.0	EC001283
ETIM 6.0	EC001283
ETIM 7.0	EC001283

### UNSPSC

UNSPSC 6.01	30211811
UNSPSC 7.0901	39121410
UNSPSC 11	39121410
UNSPSC 12.01	39121410
UNSPSC 13.2	39121410
UNSPSC 18.0	39121410
UNSPSC 19.0	39121410
UNSPSC 20.0	39121410
UNSPSC 21.0	39121410

## Approvals

### Approvals

#### Approvals

CSA / UL Recognized / KEMA-KEUR / IECCE CB Scheme / EAC

#### Ex Approvals

### Approval details

CSA		<a href="http://www.csagroup.org/services-industries/product-listing/">http://www.csagroup.org/services-industries/product-listing/</a>	13631
	B	C	
Nominal voltage UN	600 V	600 V	
Nominal current IN	125 A	125 A	
mm <sup>2</sup> /AWG/kcmil	6	6	

# Panel feed-through terminal block - HDFKV 50-VP - 0708580

## Approvals

UL Recognized		<a href="http://database.ul.com/cgi-bin/XYV/template/LISEXT/1FRAME/index.htm">http://database.ul.com/cgi-bin/XYV/template/LISEXT/1FRAME/index.htm</a>	E60425-19890329
	B	C	
Nominal voltage UN	600 V	600 V	
Nominal current IN	170 A	170 A	
mm <sup>2</sup> /AWG/kcmil	6	6	

KEMA-KEUR		<a href="http://www.dekra-certification.com">http://www.dekra-certification.com</a>	KEMA jetzt DEKRA
Nominal voltage UN	690 V		
Nominal current IN	150 A		
mm <sup>2</sup> /AWG/kcmil	50		

IECEE CB Scheme		<a href="http://www.iecee.org/">http://www.iecee.org/</a>	NL-29947
Nominal voltage UN	690 V		
Nominal current IN	150 A		
mm <sup>2</sup> /AWG/kcmil	50		

EAC		B.01687
-----	---	---------

## Accessories

### Accessories

#### Labeled terminal marker

Marker for terminal blocks - UC-TM 16 CUS - 0824621



Marker for terminal blocks, can be ordered: by sheet, white, labeled according to customer specifications, mounting type: snap into tall marker groove, for terminal block width: 16 mm, lettering field size: 15.45 x 10.5 mm, Number of individual labels: 32

## Panel feed-through terminal block - HDFKV 50-VP - 0708580

### Accessories

---

Zack Marker strip, flat - ZBF 16 CUS - 0827465



Zack Marker strip, flat, can be ordered: Strip, white, labeled according to customer specifications, mounting type: snap into flat marker groove, for terminal block width: 16 mm, lettering field size: 5.15 x 16 mm, Number of individual labels: 5

### Mounting material

---

Insertion profile - UKH 50 EP - 3009228



Insertion profile, color: silver

### Screwdriver tools

---

Screwdriver - SZS 1,2X8,0 VDE - 1205082



Screwdriver, slot-headed, VDE insulated, size: 1.2 x 8.0 x 175 mm, 2-component grip, with non-slip grip

### Terminal marking

---

Marker for terminal blocks - UC-TM 16 - 0819217



Marker for terminal blocks, Sheet, white, unlabeled, can be labeled with: BLUEMARK ID COLOR, BLUEMARK ID, BLUEMARK CLED, PLOTMARK, CMS-P1-PLOTTER, mounting type: snap into tall marker groove, for terminal block width: 16 mm, lettering field size: 15.45 x 10.5 mm, Number of individual labels: 32

## Panel feed-through terminal block - HDFKV 50-VP - 0708580

### Accessories

Zack marker strip - ZB 16:UNPRINTED - 0827461



Zack marker strip, Strip, white, unlabeled, can be labeled with: PLOTMARK, CMS-P1-PLOTTER, mounting type: snap into tall marker groove, for terminal block width: 16 mm, lettering field size: 16 x 10.5 mm, Number of individual labels: 50

---

Zack marker strip - ZB 12:UNPRINTED - 0812120



Zack marker strip, Strip, white, unlabeled, can be labeled with: PLOTMARK, CMS-P1-PLOTTER, mounting type: snap into tall marker groove, for terminal block width: 12.2 mm, lettering field size: 12 x 10.5 mm, Number of individual labels: 5

---

---