

Fastening clip - RVT-PA 6 - 3240499

Please be informed that the data shown in this PDF Document is generated from our Online Catalog. Please find the complete data in the user's documentation. Our General Terms of Use for Downloads are valid (<http://phoenixcontact.com/download>)



Plastic body-bound rivet, for hole diameter of 6 mm and a material thickness of 1.5 ... 6 mm

RoHS

Key Commercial Data

Packing unit	1 pc
Minimum order quantity	100 pc
GTIN	 4 046356 520331
GTIN	4046356520331
Weight per Piece (excluding packing)	0.400 g
Custom tariff number	39269097
Country of origin	Germany

Technical data

Product type	Filler plug
--------------	-------------

Drawings

Fastening clip - RVT-PA 6 - 3240499

Dimensional drawing

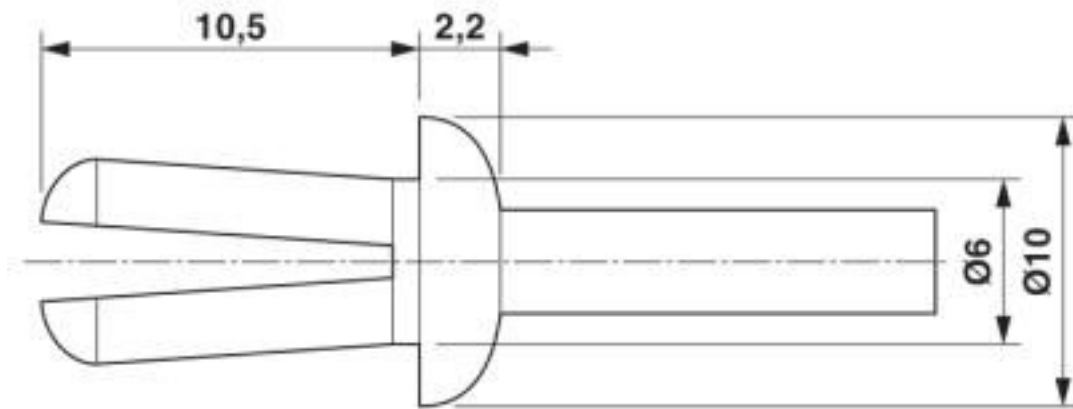

Classifications

eCl@ss

eCl@ss 4.0	27141100
eCl@ss 4.1	23120400
eCl@ss 5.0	23120400
eCl@ss 5.1	23120400
eCl@ss 6.0	27409200
eCl@ss 7.0	27409241
eCl@ss 8.0	23120402
eCl@ss 9.0	27409241

ETIM

ETIM 3.0	EC000071
ETIM 4.0	EC000071
ETIM 5.0	EC002339
ETIM 6.0	EC002450
ETIM 7.0	EC002377

UNSPSC

UNSPSC 6.01	30212109
UNSPSC 7.0901	39121708
UNSPSC 11	39121708
UNSPSC 12.01	39121708
UNSPSC 13.2	31162201
UNSPSC 19.0	31162201

