

Cable clamp - WCC 18 - 3240253

Please be informed that the data shown in this PDF Document is generated from our Online Catalog. Please find the complete data in the user's documentation. Our General Terms of Use for Downloads are valid (<http://phoenixcontact.com/download>)



Cable clamp, for DIN rails

Your advantages

- The halogen-free plastic troughs have been designed to be perfectly secure while simultaneously protecting the conductors
- Individual or bundled cables with a diameter of up to 18 mm can be installed safely and easily
- The cable clamps provide strain relief

RoHS

Key Commercial Data

Packing unit	1 pc
Minimum order quantity	25 pc
GTIN	 4 046356 464550
GTIN	4046356464550
Weight per Piece (excluding packing)	38.400 g
Custom tariff number	73269098
Country of origin	China

Technical data

Dimensions

Cable diameter	12 mm ... 18 mm
----------------	-----------------

General

Material	Steel
Coating	galvanized

Environmental Product Compliance

Cable clamp - WCC 18 - 3240253

Technical data

Environmental Product Compliance

China RoHS	Environmentally friendly use period: unlimited = EFUP-e
	No hazardous substances above threshold values

Drawings

Dimensional drawing

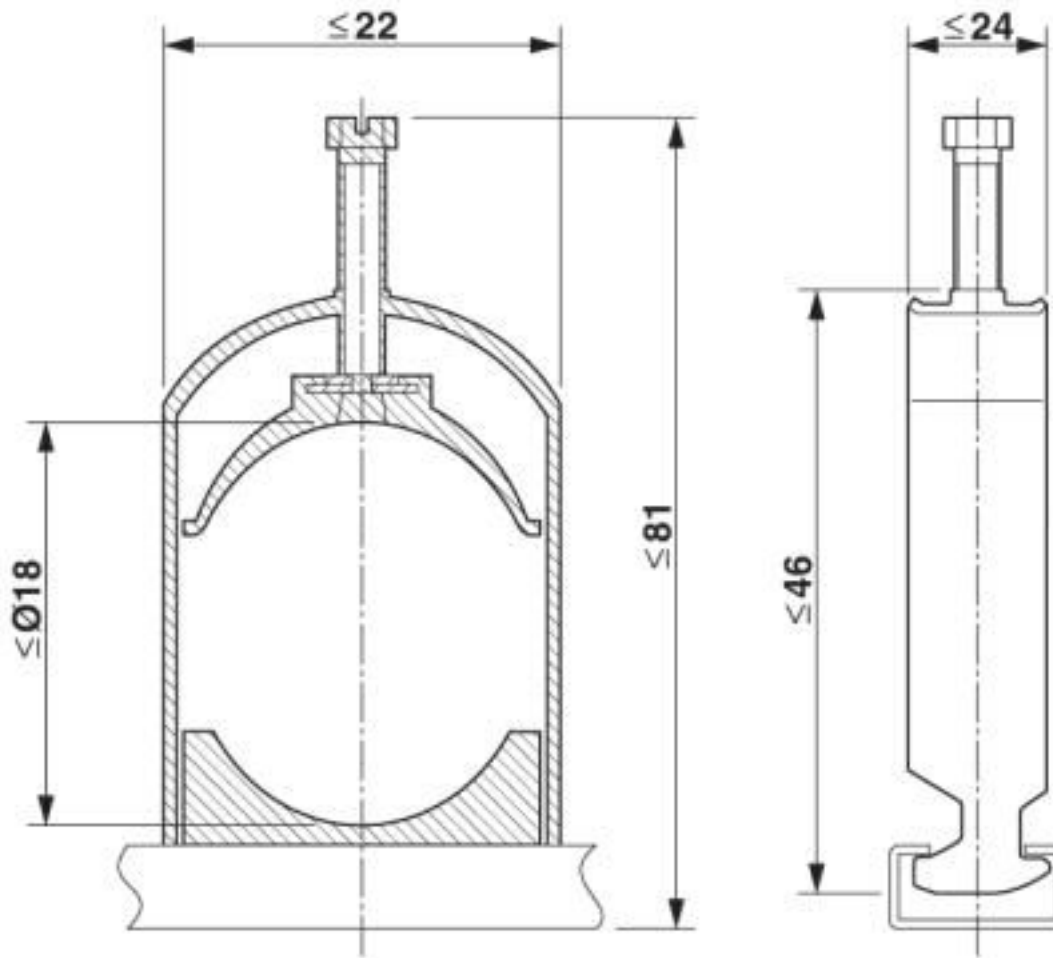

Classifications

eCl@ss

eCl@ss 10.0.1	23159090
eCl@ss 4.0	23140300
eCl@ss 4.1	23140300

Cable clamp - WCC 18 - 3240253

Classifications

eCl@ss

eCl@ss 5.0	23140300
eCl@ss 5.1	23140300
eCl@ss 6.0	23140300
eCl@ss 7.0	23140390
eCl@ss 8.0	23140390
eCl@ss 9.0	23159090

ETIM

ETIM 2.0	EC000897
ETIM 3.0	EC000897
ETIM 4.0	EC000441
ETIM 5.0	EC000454
ETIM 6.0	EC000454
ETIM 7.0	EC000454

UNSPSC

UNSPSC 6.01	30211811
UNSPSC 7.0901	39121410
UNSPSC 11	39121410
UNSPSC 12.01	39121410
UNSPSC 13.2	31162906
UNSPSC 18.0	31162906
UNSPSC 19.0	31162906
UNSPSC 20.0	31162906
UNSPSC 21.0	31162906

Accessories

Accessories

DIN rail

DIN rail perforated - NS 30/15 PERF.2000MM - 3240262



DIN rail perforated, C profile, width: 30 mm, height: 15 mm, similar to EN 60715, material: Steel, galvanized, length: 2000 mm

