

Ring cable lug - C-RC 10/M10 DIN - 3240092

Please be informed that the data shown in this PDF Document is generated from our Online Catalog. Please find the complete data in the user's documentation. Our General Terms of Use for Downloads are valid (<http://phoenixcontact.com/download>)



Ring cable lug, non-insulated, 10 mm², M10

Your advantages

- ✓ The CRIMPFOX-RC... tools from our CRIMPFOX range of crimping pliers are available for optimum crimping
- ✓ The hard-soldered press zone enables maximum conductor pull-out values to be achieved
- ✓ The ring cable lugs without plastic sleeve are made from high-quality tin-plated electrolytic copper for maximum protection against corrosion

Key Commercial Data

Packing unit	1 pc
Minimum order quantity	100 pc
GTIN	 4 046356 453097
GTIN	4046356453097
Weight per Piece (excluding packing)	3.800 g
Custom tariff number	85369010
Country of origin	China

Technical data

Dimensions

Length (b)	30 mm
Width (a)	18 mm
Maximum stripping length	11 mm
Length of insulation sleeve (c)	8 mm
Inner dimension of the insulating collar (d)	4.5 mm
Distance between the center and the insulation sleeve (e)	13 mm

Ring cable lug - C-RC 10/M10 DIN - 3240092

Technical data

Dimensions

Inner diameter (f)	10.5 mm
Material thickness (g)	1.1 mm

Ambient conditions

Ambient temperature (operation)	110 °C
---------------------------------	--------

General

Color	silver
Stripping length	11 mm
Material	Copper
Coating	tin-plated

Standards and Regulations

Design according to standard	DIN 46234
------------------------------	-----------

Environmental Product Compliance

China RoHS	Environmentally friendly use period: unlimited = EFUP-e
	No hazardous substances above threshold values

Drawings

Ring cable lug - C-RC 10/M10 DIN - 3240092

Dimensional drawing

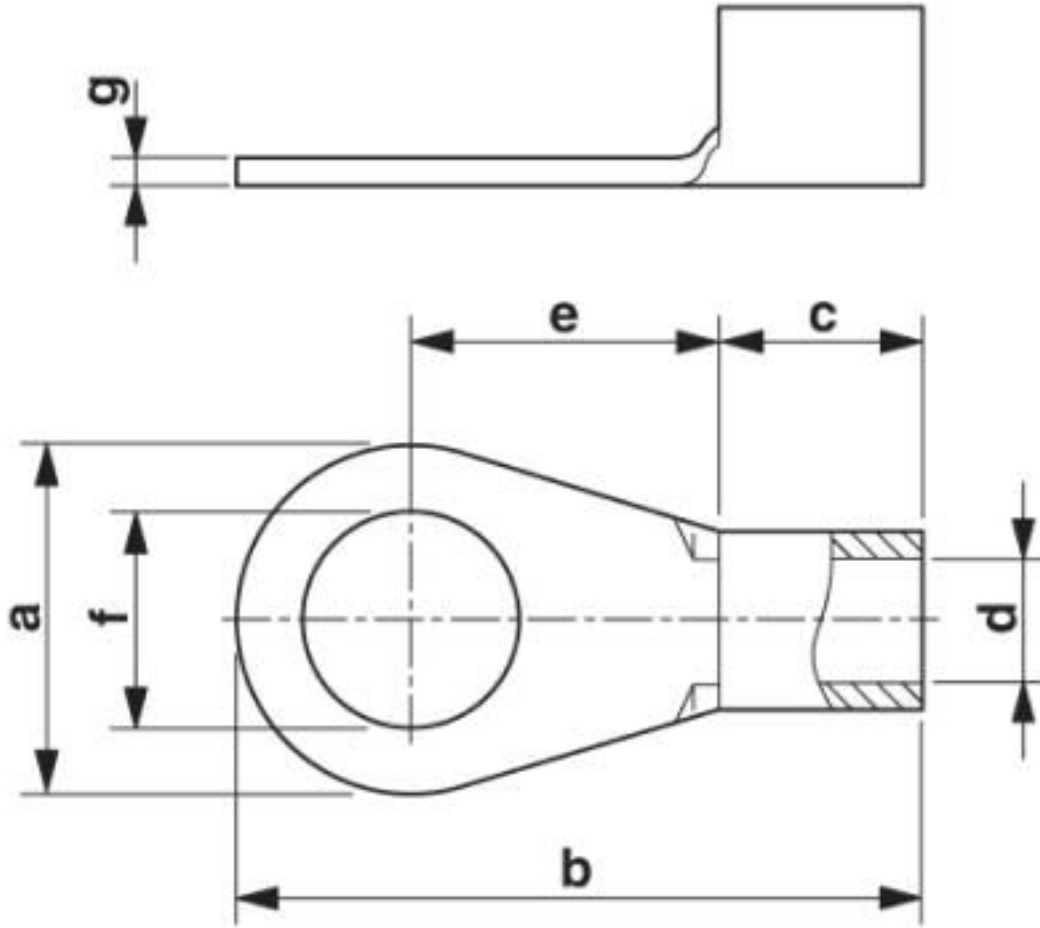

Classifications

eCl@ss

eCl@ss 10.0.1	27400204
eCl@ss 4.0	27060700
eCl@ss 4.1	27060700
eCl@ss 5.0	27400200
eCl@ss 5.1	27400200
eCl@ss 6.0	27400200
eCl@ss 7.0	27400203
eCl@ss 8.0	27400204
eCl@ss 9.0	27400204

Ring cable lug - C-RC 10/M10 DIN - 3240092

Classifications

ETIM

ETIM 2.0	EC000005
ETIM 3.0	EC000005
ETIM 4.0	EC001052
ETIM 5.0	EC001052
ETIM 6.0	EC001052
ETIM 7.0	EC001052

UNSPSC

UNSPSC 6.01	30211923
UNSPSC 7.0901	27121703
UNSPSC 11	27121703
UNSPSC 12.01	27121703
UNSPSC 13.2	27121707
UNSPSC 18.0	27121707
UNSPSC 19.0	27121707
UNSPSC 20.0	27121707
UNSPSC 21.0	27121707

Approvals

Approvals

Approvals

EAC

Ex Approvals

Approval details

EAC		EAC-Zulassung
-----	---	---------------