

Ring cable lug - C-RCI 6/M5 - 3240028

Please be informed that the data shown in this PDF Document is generated from our Online Catalog. Please find the complete data in the user's documentation. Our General Terms of Use for Downloads are valid (<http://phoenixcontact.com/download>)



Ring cable lug, yellow, 4 ... 6 mm², M5

Your advantages

- ✓ The sleeves are conically tapered to facilitate easy and correct insertion of the conductor
- ✓ The insulated ring cable lugs with plastic sleeve are hard-soldered and feature the 'EASY ENTRY' system

Key Commercial Data

Packing unit	1 pc
Minimum order quantity	50 pc
GTIN	 4 046356 452052
GTIN	4046356452052
Weight per Piece (excluding packing)	1.800 g
Custom tariff number	85369010
Country of origin	China

Technical data

Dimensions

Length (b)	26.7 mm
Width (a)	9.5 mm
Maximum stripping length	9 mm
Length of insulation sleeve (c)	14 mm
Inner dimension of the insulating collar (d)	6.6 mm
Distance between the center and the insulation sleeve (e)	8 mm
Inner diameter (f)	5.3 mm

Ring cable lug - C-RCI 6/M5 - 3240028

Technical data

Dimensions

Material thickness (g)	1 mm
------------------------	------

Ambient conditions

Ambient temperature (operation)	-20 °C ... 105 °C
Ambient temperature (assembly)	-20 °C ... 100 °C
Optimum ambient temperature (storage/transport)	20 °C 50 % Humidity (RH), store inside sealed original packaging. Avoid direct sunlight and heat.
Short-term temperature	100 °C

General

Color	yellow
Stripping length	9 mm
Components	halogen-free
Flammability rating according to UL 94	V2
Material	Copper
Insulating material	PA
Coating	tin-plated

Standards and Regulations

Flammability rating according to UL 94	V2
Design according to standard	JIS, UL, CSA

Environmental Product Compliance

China RoHS	Environmentally friendly use period: unlimited = EFUP-e
	No hazardous substances above threshold values

Drawings

Ring cable lug - C-RCI 6/M5 - 3240028

Dimensional drawing

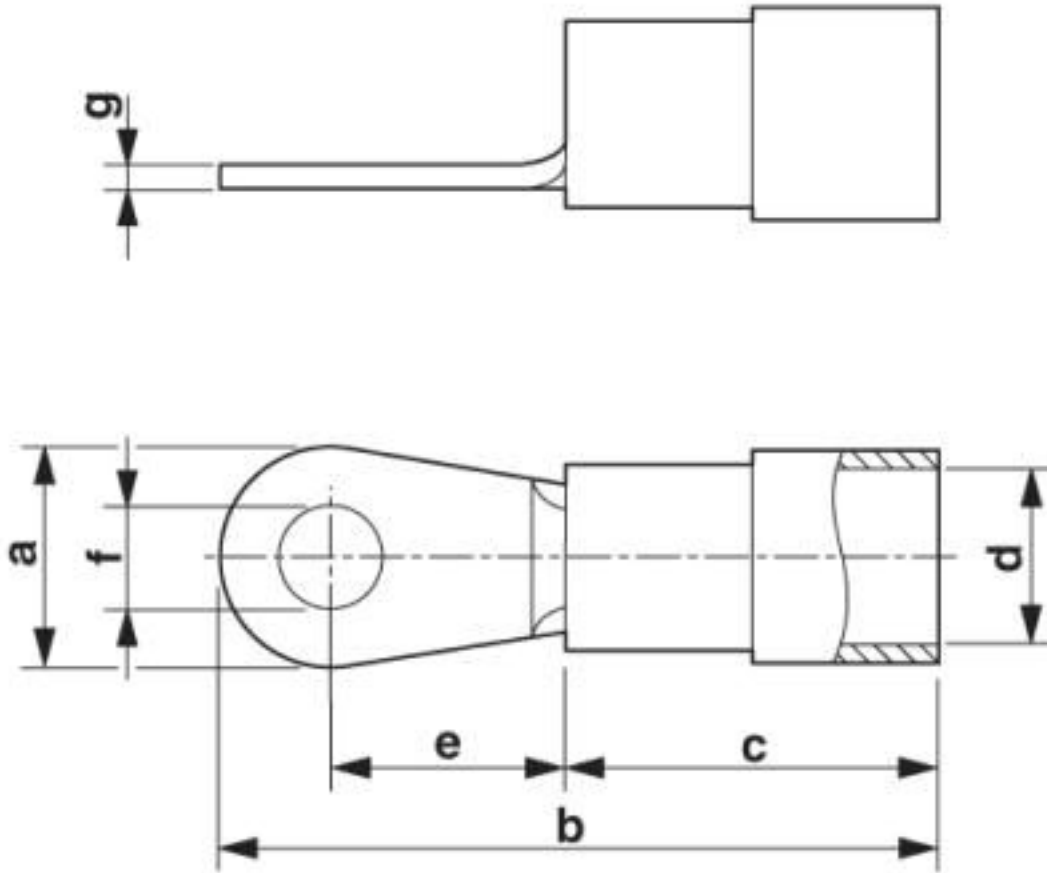

Classifications

eCl@ss

eCl@ss 10.0.1	27400204
eCl@ss 4.0	27060700
eCl@ss 4.1	27060700
eCl@ss 5.0	27400200
eCl@ss 5.1	27400200
eCl@ss 6.0	27400200
eCl@ss 7.0	27400204
eCl@ss 8.0	27400204
eCl@ss 9.0	27400204

ETIM

ETIM 2.0	EC000005
----------	----------

Ring cable lug - C-RCI 6/M5 - 3240028

Classifications

ETIM

ETIM 3.0	EC000005
ETIM 4.0	EC001052
ETIM 5.0	EC001052
ETIM 6.0	EC001052
ETIM 7.0	EC001052

UNSPSC

UNSPSC 6.01	27113201
UNSPSC 7.0901	27121703
UNSPSC 11	27121703
UNSPSC 12.01	27121703
UNSPSC 13.2	27121707
UNSPSC 18.0	27121707
UNSPSC 19.0	27121707
UNSPSC 20.0	27121707
UNSPSC 21.0	27121707

Approvals

Approvals

Approvals

EAC

Ex Approvals

Approval details

EAC		EAC-Zulassung
-----	---	---------------
