

Ferrule - AI 1 - 6 YE - 3201327

Please be informed that the data shown in this PDF Document is generated from our Online Catalog. Please find the complete data in the user's documentation. Our General Terms of Use for Downloads are valid (<http://phoenixcontact.com/download>)



Ferrule, sleeve length: 6 mm, length: 12 mm, color: yellow

Your advantages

- The AI 0,25... can also be used to process 0.14 mm² conductors
- The ferrules with plastic sleeve are made from soft tin-plated electrolytic copper
- In terms of dimensions, they correspond to DIN 46228-4: 1990-09

Key Commercial Data

Packing unit	1 pc
Minimum order quantity	100 pc
GTIN	 4 017918 094829
GTIN	4017918094829
Weight per Piece (excluding packing)	0.092 g
Custom tariff number	85369010
Country of origin	Germany

Technical data

Dimensions

Length (b)	12 mm
Maximum stripping length	9 mm
Sleeve length	6 mm
Inner dimension of the insulating collar (d)	3 mm
Ferrule diameter	1.5 mm
Insulating collar thickness	0.3 mm

Ferrule - AI 1 - 6 YE - 3201327

Technical data

Dimensions

Sleeve wall thickness	0.15 mm
-----------------------	---------

Ambient conditions

Short-term temperature	120 °C
Max. permanent temperature	105 °C (-40°C no load / 0°C dynamic load)

General

Color	yellow
Components	free from silicone and halogen
Flammability rating according to UL 94	HB
Material	CU-DHP
Coating	tin-plated (galvanic)
Conductor category	Stranded conductors, class 2, 5, 6 / B, C, K, M

Standards and Regulations

Connection in acc. with standard	CSA
Flammability rating according to UL 94	HB

Environmental Product Compliance

China RoHS	Environmentally friendly use period: unlimited = EFUP-e
	No hazardous substances above threshold values

Drawings

Dimensional drawing

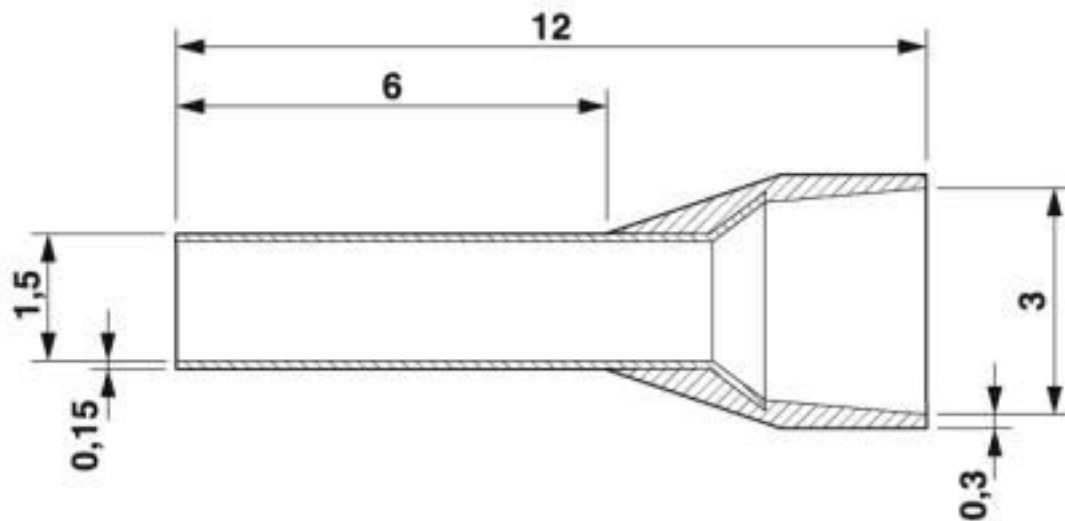

Ferrule - AI 1 - 6 YE - 3201327

Classifications

eCl@ss

eCl@ss 10.0.1	27400201
eCl@ss 4.0	27060700
eCl@ss 4.1	27060700
eCl@ss 5.0	27400200
eCl@ss 5.1	27400200
eCl@ss 6.0	27400200
eCl@ss 7.0	27400201
eCl@ss 8.0	27400201
eCl@ss 9.0	27400201

ETIM

ETIM 2.0	EC000005
ETIM 3.0	EC000005
ETIM 4.0	EC000005
ETIM 5.0	EC000005
ETIM 6.0	EC000005
ETIM 7.0	EC000005

UNSPSC

UNSPSC 6.01	30212109
UNSPSC 7.0901	27121703
UNSPSC 11	27121703
UNSPSC 12.01	27121703
UNSPSC 13.2	27121703
UNSPSC 18.0	27121703
UNSPSC 19.0	27121703
UNSPSC 20.0	27121703
UNSPSC 21.0	27121703

Approvals

Approvals

Approvals

CSA / CSAus / cCSAus

Ex Approvals

Ferrule - AI 1 - 6 YE - 3201327

Approvals

Approval details

CSA		http://www.csagroup.org/services-industries/product-listing/	247397
CSAus		http://www.csagroup.org/services-industries/product-listing/	247397
cCSAus			

Accessories

Accessories

Crimping tool

Crimping pliers - CRIMPFOX CENTRUS 6S - 1213144



Crimping pliers, for uninsulated and insulated ferrules, DIN 46228 Part 1 and 4, from 0.14 mm² ... 6 mm², also for TWIN ferrules up to 2 x 4 mm², automatic cross section adjustment, lateral insertion, equipped with fall protection

Crimping pliers - CRIMPFOX CENTRUS 6H - 1213146



Crimping pliers, for uninsulated and insulated ferrules, DIN 46228 Part 1 and 4, from 0.14 mm² ... 6 mm², also for TWIN ferrules up to 2 x 4 mm², automatic cross section adjustment, lateral insertion, equipped with fall protection

Ferrule - AI 1 - 6 YE - 3201327

Accessories

Crimping pliers - CRIMPFOX CENTRUS 10S - 1213154



Crimping pliers, for uninsulated and insulated ferrules, DIN 46228 Part 1 and 4, from 0.14 mm² ... 10 mm², also for TWIN ferrules up to 2 x 4 mm², automatic cross section adjustment, lateral insertion, equipped with fall protection

Crimping pliers - CRIMPFOX CENTRUS 10H - 1213156



Crimping pliers, for uninsulated and insulated ferrules, DIN 46228 Part 1 and 4, from 0.14 mm² ... 10 mm², also for TWIN ferrules up to 2 x 4 mm², automatic cross section adjustment, lateral insertion, equipped with fall protection

Crimping pliers - CRIMPFOX 10S - 1212045



Crimping pliers, for ferrules without insulating collar according to DIN 46228 Part 1 and ferrules with insulating collar according to DIN 46228 Part 4, 0.14 mm² ... 10 mm², unlockable pressure lock, lateral entry

Crimping pliers - CRIMPFOX 6H - 1212046



Crimping pliers, for ferrules without insulating collar according to DIN 46228 Part 1 and ferrules with insulating collar according to DIN 46228 Part 4, 0.14 mm² ... 6 mm², unlockable pressure lock, lateral entry

Crimping pliers - CRIMPFOX 2,5-M - 1212719



Crimping pliers, for ferrules without insulating collar according to DIN 46228 Part 1 and ferrules with insulating collar according to DIN 46228 Part 4, 0.25 mm² ... 2.5 mm², lateral entry, trapezoidal crimp

Ferrule - AI 1 - 6 YE - 3201327

Accessories

Crimping pliers - CRIMPFOX 6-M - 1212720



Crimping pliers, for ferrules without insulating collar according to DIN 46228 Part 1 and ferrules with insulating collar according to DIN 46228 Part 4, 0.25 mm² ... 6.0 mm², lateral entry, trapezoidal crimp

Crimping pliers - CRIMPFOX 6 - 1212034



Crimping pliers, for ferrules without insulating collar according to DIN 46228 Part 1 and ferrules with insulating collar according to DIN 46228 Part 4, 0.25 mm² ... 6.0 mm², lateral entry, trapezoidal crimp

Crimping pliers - CRIMPFOX 6T - 1212037



Crimping pliers, for ferrules without insulating collar according to DIN 46228 Part 1 and ferrules with insulating collar according to DIN 46228 Part 4, 0.25 mm² ... 6 mm², lateral entry, trapezoidal crimp

Crimping pliers - CRIMPFOX 6T-F - 1212038



Crimping pliers, for ferrules without insulating collar according to DIN 46228 Part 1 and ferrules with insulating collar according to DIN 46228 Part 4, 0.25 mm² ... 6 mm², front entry, trapezoidal crimp

Crimping pliers - CRIMPFOX 6S-F - 1212043



Crimping pliers, for ferrules without insulating collar according to DIN 46228 Part 1 and ferrules with insulating collar according to DIN 46228 Part 4, 0.5 mm² ... 6 mm², front entry, square crimp

Ferrule - AI 1 - 6 YE - 3201327

Accessories

Crimping pliers - CRIMPFOX 16 S - 1207983



Crimping pliers for ferrules up to 16 mm²
