

## Ferrule - AI 25 -16 YE - 3200577

Please be informed that the data shown in this PDF Document is generated from our Online Catalog. Please find the complete data in the user's documentation. Our General Terms of Use for Downloads are valid (<http://phoenixcontact.com/download>)



Ferrule, sleeve length: 16 mm, length: 29 mm, color: yellow

### Your advantages

- ✓ The ferrules with plastic sleeve are made from soft tin-plated electrolytic copper
- ✓ The insulation reliability of close connections is increased and the splicing of wires is prevented
- ✓ The AI 0,25.. ferrules can also be used to process 0.14 mm<sup>2</sup> conductors

### Key Commercial Data

Packing unit	1 pc
Minimum order quantity	50 pc
GTIN	 4 017918 094188
GTIN	4017918094188
Weight per Piece (excluding packing)	1.208 g
Custom tariff number	85369010
Country of origin	Germany

### Technical data

#### Dimensions

Length (b)	29 mm
Maximum stripping length	20 mm
Sleeve length	16 mm
Inner dimension of the insulating collar (d)	11 mm
Ferrule diameter	7.3 mm
Insulating collar thickness	0.5 mm

# Ferrule - AI 25 -16 YE - 3200577

## Technical data

### Dimensions

Sleeve wall thickness	0.2 mm
-----------------------	--------

### Ambient conditions

Short-term temperature	120 °C
Max. permanent temperature	105 °C (-40°C no load / 0°C dynamic load)

### General

Color	yellow
Components	free from silicone and halogen
Flammability rating according to UL 94	HB
Material	CU-DHP
Coating	tin-plated (galvanic)
Conductor category	Stranded conductors, class 2, 5, 6 / B, C, K, M

### Standards and Regulations

Connection in acc. with standard	CSA
Flammability rating according to UL 94	HB

### Environmental Product Compliance

China RoHS	Environmentally friendly use period: unlimited = EFUP-e
	No hazardous substances above threshold values

## Drawings

Dimensional drawing

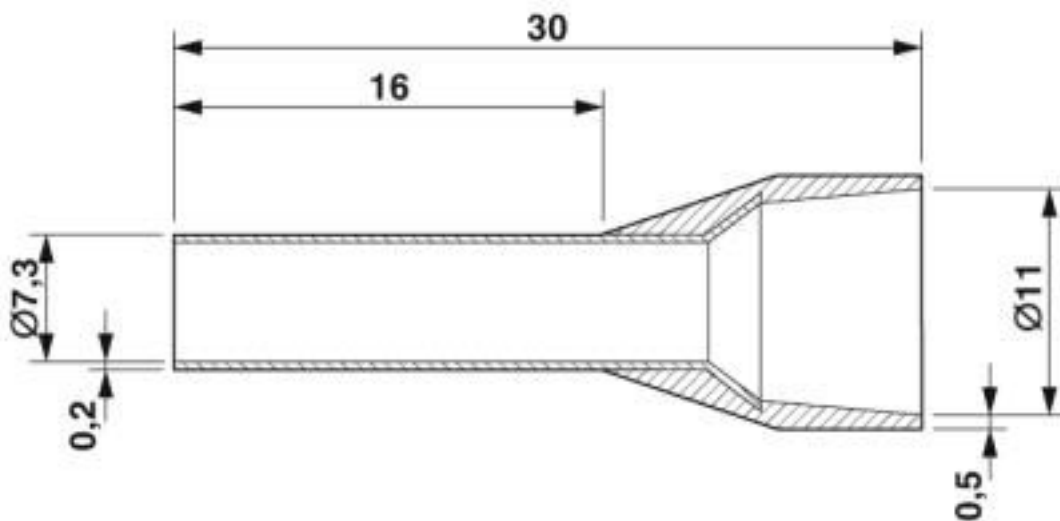

# Ferrule - AI 25 -16 YE - 3200577

## Classifications

### eCl@ss

eCl@ss 10.0.1	27400201
eCl@ss 4.0	27060700
eCl@ss 4.1	27060700
eCl@ss 5.0	27400200
eCl@ss 5.1	27400200
eCl@ss 6.0	27400200
eCl@ss 7.0	27400201
eCl@ss 8.0	27400201
eCl@ss 9.0	27400201

### ETIM

ETIM 2.0	EC000005
ETIM 3.0	EC000005
ETIM 4.0	EC000005
ETIM 5.0	EC000005
ETIM 6.0	EC000005
ETIM 7.0	EC000005

### UNSPSC

UNSPSC 6.01	30212109
UNSPSC 7.0901	27121703
UNSPSC 11	27121703
UNSPSC 12.01	27121703
UNSPSC 13.2	27121703
UNSPSC 18.0	27121703
UNSPSC 19.0	27121703
UNSPSC 20.0	27121703
UNSPSC 21.0	27121703

## Approvals

### Approvals

---

Approvals

CSA / UL Listed / cUL Listed / CSAus / cULus Listed / cCSAus





---

Ex Approvals

# Ferrule - AI 25 -16 YE - 3200577

## Approvals

### Approval details

CSA		<a href="http://www.csagroup.org/services-industries/product-listing/">http://www.csagroup.org/services-industries/product-listing/</a>	247397
UL Listed		<a href="http://database.ul.com/cgi-bin/XYV/template/LISEXT/1FRAME/index.htm">http://database.ul.com/cgi-bin/XYV/template/LISEXT/1FRAME/index.htm</a>	E488001
cUL Listed		<a href="http://database.ul.com/cgi-bin/XYV/template/LISEXT/1FRAME/index.htm">http://database.ul.com/cgi-bin/XYV/template/LISEXT/1FRAME/index.htm</a>	E488001
CSAus		<a href="http://www.csagroup.org/services-industries/product-listing/">http://www.csagroup.org/services-industries/product-listing/</a>	247397
cULus Listed			
cCSAus	