

Test terminal strip - PTWE 6-2/15 - 3069838

Please be informed that the data shown in this PDF Document is generated from our Online Catalog. Please find the complete data in the user's documentation. Our General Terms of Use for Downloads are valid (<http://phoenixcontact.com/download>)



Test terminal strip, nom. voltage: 400 V AC/DC, connection method: Push-in connection, number of connections: 30, number of positions: 15, cross section: 0.5 mm² - 10 mm², AWG: 20 - 8, width: 155.8 mm, height: 56.5 mm, color: gray, mounting type: Wall mounting

Your advantages

- ✓ Space saving, thanks to compact, modular test terminal strips
- ✓ Cost-effective, thanks to the tailored, modular design and use of standardized CLIPLINE complete accessories
- ✓ The integrated, robust switch contact is designed for the most stringent demands, and the use of high-quality materials ensures the transmission of signal currents, even after multiple actuations
- ✓ Maximum safety with leading and automatic transformer short circuit



COMPLETE RoHS

Key Commercial Data

Packing unit	1
GTIN	
GTIN	4046356962162
Custom tariff number	85369010

Technical data

General

Number of positions	15
Number of levels	1
Number of connections	30
Potentials	15
Nominal cross section	6 mm ²
Color	gray
Insulating material	PA

Test terminal strip - PTWE 6-2/15 - 3069838

Technical data

General

Flammability rating according to UL 94	V0
Rated surge voltage	4 kV
Test surge voltage	5 kV
Overvoltage category	III
Insulating material group	I
Maximum power dissipation for nominal condition	1.31 W
Maximum load current	30 A (with 6 mm ² conductor cross section)
Nominal voltage U _N	400 V AC/DC
Open side panel	No
Terminal block mounting	0.8 Nm ... 1 Nm
Ambient temperature (operation)	-60 °C ... 85 °C
Ambient temperature (storage/transport)	-25 °C ... 55 °C (For a short time, not exceeding 24 h, -60 to +70 °C)
Permissible humidity (storage/transport)	30 % ... 70 %
Ambient temperature (assembly)	-5 °C ... 70 °C
Ambient temperature (actuation)	-5 °C ... 70 °C
Shock protection test specification	DIN EN 50274 (VDE 0660-514):2002-11
Back of the hand protection	guaranteed
Finger protection	guaranteed
Note regarding shock protection	When test disconnect plug is plugged in.
Result of surge voltage test	Test passed
Result of power-frequency withstand voltage test	Test passed
Power frequency withstand voltage setpoint	1.89 kV
Result of the test for mechanical stability of terminal points (5 x conductor connection)	Test passed
Result of bending test	Test passed
Bending test rotation speed	10 rpm
Bending test turns	135
Bending test conductor cross section/weight	0.5 mm ² / 0.3 kg
	6 mm ² / 1.4 kg
	10 mm ² / 2 kg
Tensile test result	Test passed
Result of tight fit on support	Test passed
Setpoint	5 N
Result of voltage-drop test	Test passed
Result of temperature-rise test	Test passed
Requirement temperature-rise test	Increase in temperature ≤ 45 K
Short circuit stability result	Test passed

Test terminal strip - PTWE 6-2/15 - 3069838

Technical data

General

Conductor cross section short circuit testing	4 mm ²
Short-time current	0.5 kA
Conductor cross section short circuit testing	4 mm ²
Short-time current	0.3 kA
Conductor cross section short circuit testing	4 mm ²
Short-time current	0.15 kA
Result of thermal test	Test passed
Ageing test for screwless modular terminal block temperature cycles	192
Proof of thermal characteristics (needle flame) effective duration	30 s
Result of aging test	Test passed
Oscillation, broadband noise test result	Test passed
Test specification, oscillation, broadband noise	DIN EN 50155 (VDE 0115-200):2008-03
Test spectrum	Service life test category 2, bogie-mounted
Test frequency	f ₁ = 5 Hz to f ₂ = 250 Hz
ASD level	6.12 (m/s ²) ² /Hz
Acceleration	3.12 g
Test duration per axis	5 h
Test directions	X-, Y- and Z-axis
Shock test result	Test passed
Test specification, shock test	DIN EN 50155 (VDE 0115-200):2008-03
Shock form	Half-sine
Acceleration	30g
Shock duration	18 ms
Number of shocks per direction	3
Test directions	X-, Y- and Z-axis (pos. and neg.)
Relative insulation material temperature index (Elec., UL 746 B)	130 °C
Temperature index of insulation material (DIN EN 60216-1 (VDE 0304-21))	125 °C
Static insulating material application in cold	-60 °C
Surface flammability NFPA 130 (ASTM E 162)	passed
Specific optical density of smoke NFPA 130 (ASTM E 662)	passed
Calorimetric heat release NFPA 130 (ASTM E 1354)	27,5 MJ/kg
Smoke gas toxicity NFPA 130 (SMP 800C)	passed
Fire protection for rail vehicles (DIN EN 45545-2) R22	HL 1 - HL 3
Fire protection for rail vehicles (DIN EN 45545-2) R23	HL 1 - HL 3
Fire protection for rail vehicles (DIN EN 45545-2) R24	HL 1 - HL 3
Fire protection for rail vehicles (DIN EN 45545-2) R26	HL 1 - HL 3

Dimensions

Test terminal strip - PTWE 6-2/15 - 3069838

Technical data

Dimensions

Width	155.8 mm
Length	81 mm
Height	56.5 mm
Plate thickness	1 mm ... 4 mm
Pitch	8.2 mm

Connection data

Connection	1 level
Connection method	Push-in connection
Stripping length	12 mm
Connection in acc. with standard	IEC 60947-7-1
Conductor cross section solid min.	0.5 mm ²
Conductor cross section solid max.	10 mm ²
Conductor cross section AWG min.	20
Conductor cross section AWG max.	8
Conductor cross section flexible min.	0.5 mm ²
Conductor cross section flexible max.	6 mm ²
Min. AWG conductor cross section, flexible	20
Max. AWG conductor cross section, flexible	10
Conductor cross section flexible, with ferrule without plastic sleeve min.	0.5 mm ²
Conductor cross section flexible, with ferrule without plastic sleeve max.	6 mm ²
Conductor cross section flexible, with ferrule with plastic sleeve min.	0.5 mm ²
Conductor cross section flexible, with ferrule with plastic sleeve max.	6 mm ²
Two conductors with the same cross section, flexible, with TWIN ferrules, with plastic sleeve, minimum	0.5 mm ²
Two conductors with the same cross section, flexible, with TWIN ferrules, with plastic sleeve, maximum	1.5 mm ²
Connection cross sections directly pluggable	1 mm ² 10 mm ²
Conductor cross section solid min.	1 mm ²
Conductor cross section solid max.	10 mm ²
Conductor cross section flexible, with ferrule without plastic sleeve min.	1 mm ²
Conductor cross section flexible, with ferrule without plastic sleeve max.	6 mm ²
Conductor cross section flexible, with ferrule with plastic sleeve min.	1 mm ²
Conductor cross section flexible, with ferrule with plastic sleeve max.	6 mm ²
Internal cylindrical gage	A5

Mounting

Mounting type	Wall mounting
Plate thickness	1 mm ... 4 mm

Test terminal strip - PTWE 6-2/15 - 3069838

Technical data

Mounting

Min. tightening torque of the mounting screw:	0.8 Nm
Max. tightening torque of the mounting screw:	1 Nm

Standards and Regulations

Connection in acc. with standard	IEC 60947-7-1
Flammability rating according to UL 94	V0

Environmental Product Compliance

REACH SVHC	Lead 7439-92-1
China RoHS	Environmentally friendly use period: unlimited = EFUP-e
	No hazardous substances above threshold values

Drawings

Test terminal strip - PTWE 6-2/15 - 3069838

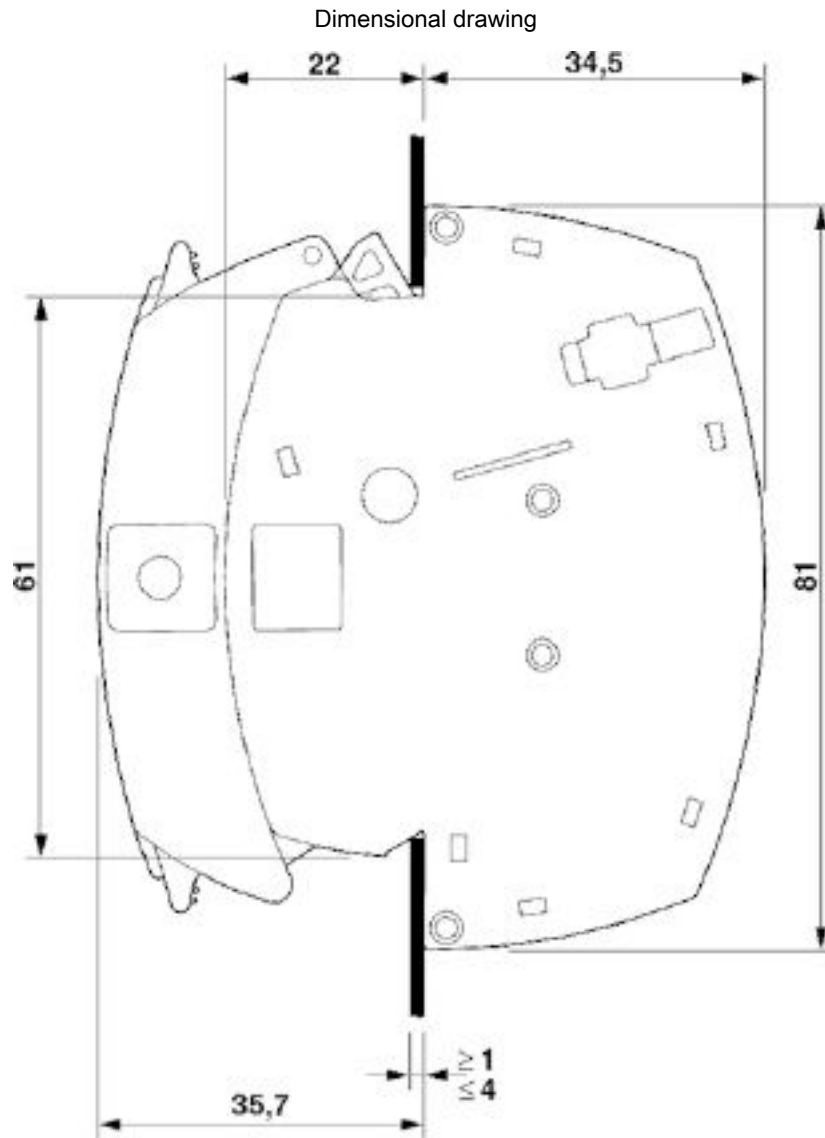

Test terminal strip - PTWE 6-2/15 - 3069838

Dimensional drawing

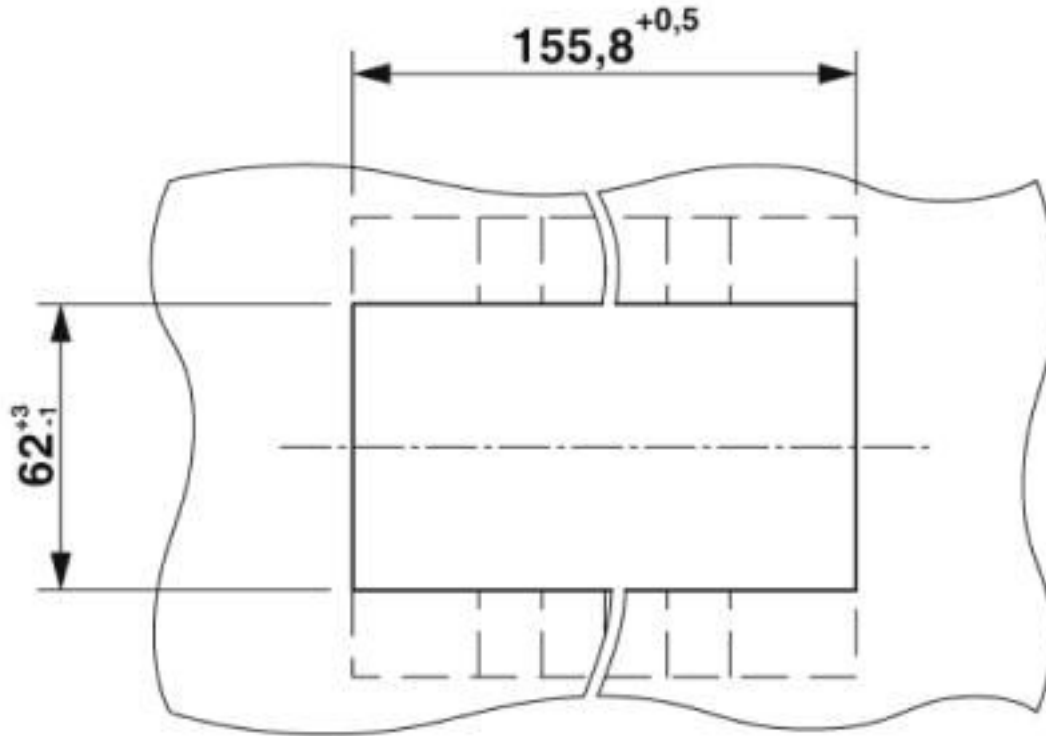

Circuit diagram



Classifications

eCl@ss

eCl@ss 10.0.1	27141126
eCl@ss 5.0	27141100
eCl@ss 5.1	27141100
eCl@ss 6.0	27141100
eCl@ss 7.0	27141126
eCl@ss 8.0	27141126
eCl@ss 9.0	27141126

Test terminal strip - PTWE 6-2/15 - 3069838

Classifications

ETIM

ETIM 4.0	EC000897
ETIM 5.0	EC000902
ETIM 6.0	EC000902
ETIM 7.0	EC000902

UNSPSC

UNSPSC 13.2	39121410
UNSPSC 18.0	39121410
UNSPSC 19.0	39121410
UNSPSC 20.0	39121410
UNSPSC 21.0	39121410

Approvals

Approvals

Approvals

CSA / UL Recognized / cUL Recognized / EAC / EAC / cULus Recognized

Ex Approvals

Approval details

CSA		http://www.csagroup.org/services-industries/product-listing/	13631
	B	C	
Nominal voltage UN	600 V	600 V	
Nominal current IN	20 A	20 A	
mm ² /AWG/kcmil	20-8	20-8	

UL Recognized		http://database.ul.com/cgi-bin/XYV/template/LISEXT/1FRAME/index.htm	FILE E 60425
	D		
Nominal voltage UN	300 V		

Test terminal strip - PTWE 6-2/15 - 3069838

Approvals

	D
Nominal current I _N	10 A
mm ² /AWG/kcmil	20-8

cUL Recognized		http://database.ul.com/cgi-bin/XYV/template/LISEXT/1FRAME/index.htm	FILE E 60425
	D		
Nominal voltage U _N	300 V		
Nominal current I _N	10 A		
mm ² /AWG/kcmil	20-8		

EAC		RU C- DE.AI30.B.01102
-----	--	--------------------------

EAC		RU C- DE.BL08.B.00682
-----	--	--------------------------

cULus Recognized	
------------------	--

Accessories

Accessories

Blind plug

Dummy plug - FBP-2/15 - 3069886



Dummy plug, pitch: 8.2 mm, length: 72.9 mm, width: 155.4 mm, number of positions: 15, color: gray

Coding element

Test terminal strip - PTWE 6-2/15 - 3069838

Accessories

Coding profile - PC-UTWE-TRI - 3069897



Coding profile, For UTWE 6-2 and UTRE 6-2 block, design: delta, length: 44.7 mm, width: 10.7 mm, height: 4.3 mm, color: red

Cover profile

Cover profile - AP RSC-T - 3059139



Cover profile, for covering terminal strips, directly snapped onto RBO... and RSC... test disconnect terminal blocks. Length supplied: 1 m

Cover profile carrier

Cover profile carrier - APH-UTWE 6-2 - 3069057



Cover profile carrier, width: 8 mm, height: 56.6 mm, material: PA, length: 80.9 mm, color: gray

Documentation

Mounting material - PT-IL - 3208090



Operating decal for the push-in Technology

Jumper

Test terminal strip - PTWE 6-2/15 - 3069838

Accessories

Plug-in bridge - FBS 2-8 - 3030284



Plug-in bridge, pitch: 8.2 mm, width: 14.7 mm, number of positions: 2, color: red

Plug-in bridge - FBS 3-8 - 3030297



Plug-in bridge, pitch: 8.2 mm, width: 22.9 mm, number of positions: 3, color: red

Plug-in bridge - FBS 4-8 - 3030307



Plug-in bridge, pitch: 8.2 mm, width: 31.1 mm, number of positions: 4, color: red

Plug-in bridge - FBS 5-8 - 3030310



Plug-in bridge, pitch: 8.2 mm, width: 39.3 mm, number of positions: 5, color: red

Plug-in bridge - FBS 6-8 - 3032470



Plug-in bridge, pitch: 8.2 mm, width: 47.5 mm, number of positions: 6, color: red

Test terminal strip - PTWE 6-2/15 - 3069838

Accessories

Plug-in bridge - FBS 10-8 - 3030323



Plug-in bridge, pitch: 8.2 mm, width: 80.3 mm, number of positions: 10, color: red

Plug-in bridge - FBSR 16-8 - 3033816



Plug-in bridge, pitch: 8.2 mm, width: 129.5 mm, number of positions: 16, color: red

Plug-in bridge - FBS 1/3-8 - 3032363



Plug-in bridge, pitch: 8.2 mm, width: 22.9 mm, number of positions: 3, pin assignment: 1,3, color: red

Plug-in bridge - FBS 1/4-8 - 3032376



Plug-in bridge, pitch: 8.2 mm, width: 31.1 mm, number of positions: 4, pin assignment: 1, 4, color: red

Plug-in bridge - FBS 1/3/5-8 - 3032389



Plug-in bridge, pitch: 8.2 mm, width: 39.3 mm, number of positions: 5, pin assignment: 1,3,5, color: red

Test terminal strip - PTWE 6-2/15 - 3069838

Accessories

Plug-in bridge - FBS 1/4/7/10-8 - 3032402



Plug-in bridge, pitch: 8.2 mm, width: 80.3 mm, number of positions: 10, pin assignment: 1,4,7,10, color: red

Plug-in bridge - FBS 2-8 CT - 3033830



Plug-in bridge, pitch: 8.2 mm, width: 14.7 mm, number of positions: 2, color: orange

Plug-in bridge - FBS 3-8 CT - 3033831



Plug-in bridge, pitch: 8.2 mm, width: 22.9 mm, number of positions: 3, color: orange

Plug-in bridge - FBS 4-8 CT - 3033832



Plug-in bridge, pitch: 8.2 mm, width: 31.1 mm, number of positions: 4, color: orange

Plug-in bridge - FBS 10-8 CT - 3033833



Plug-in bridge, pitch: 8.2 mm, width: 80.3 mm, number of positions: 10, color: orange

Test terminal strip - PTWE 6-2/15 - 3069838

Accessories

Plug-in bridge - FBS 2-8 BU - 3032567



Plug-in bridge, pitch: 8.2 mm, width: 14.7 mm, number of positions: 2, color: blue

Plug-in bridge - FBS 3-8 BU - 3032570



Plug-in bridge, pitch: 8.2 mm, width: 22.9 mm, number of positions: 3, color: blue

Plug-in bridge - FBS 4-8 BU - 3032583



Plug-in bridge, pitch: 8.2 mm, width: 31.1 mm, number of positions: 4, color: blue

Plug-in bridge - FBS 5-8 BU - 3032596



Plug-in bridge, pitch: 8.2 mm, width: 39.3 mm, number of positions: 5, color: blue

Plug-in bridge - FBS 6-8 BU - 3032677



Plug-in bridge, pitch: 8.2 mm, width: 47.5 mm, number of positions: 6, color: blue

Test terminal strip - PTWE 6-2/15 - 3069838

Accessories

Plug-in bridge - FBS 10-8 BU - 3032606



Plug-in bridge, pitch: 8.2 mm, width: 80.3 mm, number of positions: 10, color: blue

Labeled terminal marker

Zack marker strip - ZB 8 CUS - 0825011



Zack marker strip, can be ordered: Strip, white, labeled according to customer specifications, mounting type: snap into tall marker groove, for terminal block width: 8.2 mm, lettering field size: 10.5 x 8.15 mm, Number of individual labels: 10

Marker for terminal blocks - UC-TM 8 CUS - 0824597



Marker for terminal blocks, can be ordered: by sheet, white, labeled according to customer specifications, mounting type: snap into tall marker groove, for terminal block width: 8.2 mm, lettering field size: 7.6 x 10.5 mm, Number of individual labels: 56

Marker for terminal blocks - UCT-TM 8 CUS - 0829616



Marker for terminal blocks, can be ordered: by sheet, white, labeled according to customer specifications, mounting type: snap into tall marker groove, for terminal block width: 8.2 mm, lettering field size: 7.6 x 10.5 mm, Number of individual labels: 42

Zack marker strip - ZB 8,LGS:FORTL.ZAHLEN - 1052015



Zack marker strip, Strip, white, labeled, can be labeled with: CMS-P1-PLOTTER, printed horizontally: consecutive numbers 1 ... 10, 11 ... 20, etc. up to 91 ... 100, mounting type: snap into tall marker groove, for terminal block width: 8.2 mm, lettering field size: 10.5 x 8.15 mm, Number of individual labels: 10

Test terminal strip - PTWE 6-2/15 - 3069838

Accessories

Zack marker strip - ZB 8,QR:FORTL.ZAHLEN - 1052028



Zack marker strip, Strip, white, labeled, can be labeled with: CMS-P1-PLOTTER, Printed vertically: consecutive numbers 1 ... 10, 11 ... 20, etc. up to 91 ... 100, mounting type: snap into tall marker groove, for terminal block width: 8.2 mm, lettering field size: 10.5 x 8.15 mm, Number of individual labels: 10

Marker for terminal blocks - ZB 8,LGS:L1-N,PE - 1052413



Marker for terminal blocks, Strip, white, labeled, can be labeled with: CMS-P1-PLOTTER, horizontal: L1, L2, L3, N, PE, L1, L2, L3, N, PE, mounting type: snap into tall marker groove, for terminal block width: 8.2 mm, lettering field size: 10.5 x 8.15 mm, Number of individual labels: 10

Screwdriver tools

Screwdriver - SZF 2-0,8X4,0 - 1204520



Actuation tool, for ST terminal blocks, also suitable for use as a bladed screwdriver, size: 0.8 x 4.0 x 100 mm, 2-component grip, with non-slip grip

Terminal marking

Zack marker strip - ZB 8:UNBEDRUCKT - 1052002



Zack marker strip, Strip, white, unlabeled, can be labeled with: CMS-P1-PLOTTER, PLOTMARK, mounting type: snap into tall marker groove, for terminal block width: 8.2 mm, lettering field size: 10.5 x 8.15 mm, Number of individual labels: 10

Marker for terminal blocks - UC-TM 8 - 0818072



Marker for terminal blocks, Sheet, white, unlabeled, can be labeled with: BLUEMARK ID COLOR, BLUEMARK ID, BLUEMARK CLED, PLOTMARK, CMS-P1-PLOTTER, mounting type: snap into tall marker groove, for terminal block width: 8.2 mm, lettering field size: 7.6 x 10.5 mm, Number of individual labels: 56

Test terminal strip - PTWE 6-2/15 - 3069838

Accessories

Marker for terminal blocks - UCT-TM 8 - 0828740



Marker for terminal blocks, Sheet, white, unlabeled, can be labeled with: TOPMARK NEO, TOPMARK LASER, BLUEMARK ID COLOR, BLUEMARK ID, BLUEMARK CLED, THERMOMARK PRIME, THERMOMARK CARD 2.0, THERMOMARK CARD, mounting type: snap into tall marker groove, for terminal block width: 8.2 mm, lettering field size: 7.6 x 10.5 mm, Number of individual labels: 42

Marker for terminal blocks - TMT (EX9,5)R - 0828295



Marker for terminal blocks, Roll, white, unlabeled, can be labeled with: THERMOMARK ROLL 2.0, THERMOMARK ROLL, THERMOMARK ROLL X1, THERMOMARK ROLLMASTER 300/600, THERMOMARK X1.2, mounting type: snap into universal marker groove, snap into tall marker groove, for terminal block width: 50000 mm, lettering field size: 9.5 x 50000 mm, Number of individual labels: 1

Marker for terminal blocks - US-TM 100 - 0829255



Marker for terminal blocks, Card, white, unlabeled, can be labeled with: BLUEMARK ID COLOR, BLUEMARK ID, THERMOMARK PRIME, THERMOMARK CARD 2.0, THERMOMARK CARD, mounting type: snap into universal marker groove, lettering field size: 104 x 9.8 mm, Number of individual labels: 13

Test plug terminal block

Test plug - FTPR-2/15 - 3001693



Test plug, Freely configurable, with twist grip, number of positions: 15, width: 154.9 mm, color: gray

Test plug - FTP-2/15 - 3001717



Test plug, freely configurable, number of positions: 15, width: 154.9 mm, color: gray

Test terminal strip - PTWE 6-2/15 - 3069838

Accessories

Test socket

Test adapter - PAI-4-N GY - 3032871



4 mm test adapter, for terminal blocks with 5.2 mm, 6.2 mm and 8.2 mm pitch

Test adapter - PAI-4-FIX BU - 3032729



Test adapter, for 4 mm test plug and terminal blocks with 8.2 mm pitch, color: blue

Test adapter - PAI-4-FIX OG - 3034455



4 mm test adapter, for terminal blocks with 8.2 mm pitch

Test adapter - PAI-4-FIX YE - 3032745



Test adapter, for 4 mm test plug and terminal blocks with 8.2 mm pitch, color: yellow

Test adapter - PAI-4-FIX RD - 3032732



Test adapter, for 4 mm test plug and terminal blocks with 8.2 mm pitch, color: red

Test terminal strip - PTWE 6-2/15 - 3069838

Accessories

Test adapter - PAI-4-FIX GN - 3032758



Test adapter, for 4 mm test plug and terminal blocks with 8.2 mm pitch, color: green

Test adapter - PAI-4-FIX BK - 3032774



Test adapter, for 4 mm test plug and terminal blocks with 8.2 mm pitch, color: black

Test adapter - PAI-4-FIX GY - 3032790



Test adapter, for 4 mm test plug and terminal blocks with 8.2 mm pitch, color: gray

Test adapter - PAI-4-FIX VT - 3032761



Test adapter, for 4 mm test plug and terminal blocks with 4.2 mm ... 8.2 mm pitch, color: violet

Test adapter - PAI-4-FIX BN - 3032787



Test adapter, for 4 mm test plug and terminal blocks with 8.2 mm pitch, color: brown

Test terminal strip - PTWE 6-2/15 - 3069838

Accessories

Test adapter - PAI-4-FIX WH - 3032797



4 mm test adapter, for terminal blocks with 8.2 mm pitch

Test adapter - PAIS-4-FIX GY - 3032791



Test adapter, for 4 mm test plug and terminal blocks with 5.2 mm, 6.2 mm, and 8.2 mm pitch, color: gray

Test adapter - PAIS-4-FIX BK - 3032792



Test adapter, for 4 mm test plug and terminal blocks with 5.2 mm, 6.2 mm, and 8.2 mm pitch, color: black

Test adapter - PAIS-4-FIX RD - 3032793



Test adapter, for 4 mm test plug and terminal blocks with 5.2 mm, 6.2 mm, and 8.2 mm pitch, color: red

Test adapter - PAIS-4-FIX BU - 3032798



Test adapter, for 4 mm test plug and terminal blocks with 5.2 mm, 6.2 mm, and 8.2 mm pitch, color: blue

Test terminal strip - PTWE 6-2/15 - 3069838

Accessories

Test adapter - PAIS-4-FIX YE - 3032799



Test adapter, for 4 mm test plug and terminal blocks with 5.2 mm, 6.2 mm, and 8.2 mm pitch, color: yellow

Test adapter - PAIS-4-FIX GN - 3032801



Test adapter, for 4 mm test plug and terminal blocks with 5.2 mm, 6.2 mm, and 8.2 mm pitch, color: green

Test adapter - PAIS-4-FIX VT - 3032802



Test adapter, for 4 mm test plug and terminal blocks with 5.2 mm, 6.2 mm, and 8.2 mm pitch, color: violet

Female test connector - PSBJ-URTK 6 FARBLOS - 3026450



Female test connector, color: transparent

Female test connector - PSBJ-URTK 6 RD - 3026719



Female test connector, color: red

Test terminal strip - PTWE 6-2/15 - 3069838

Accessories

Female test connector - PSBJ-URTK 6 BU - 3026434



Female test connector, color: blue

Female test connector - PSBJ-URTK 6 YE - 3026405



Female test connector, color: yellow

Female test connector - PSBJ-URTK 6 GN - 3026418



Female test connector, color: green

Female test connector - PSBJ-URTK 6 VT - 3026421



Female test connector, color: violet

Female test connector - PSBJ-URTK 6 GY - 3026612



Female test connector, color: gray

Test terminal strip - PTWE 6-2/15 - 3069838

Accessories

Female test connector - PSBJ-URTK 6 BK - 3026447



Female test connector, color: black

Female test connector - PSBJ-URTK 6 BN - 3026971



Female test connector, color: brown

Female test connector - PSBJ-URTK 6 WH - 3026448



Female test connector, color: white
