

Plug - UP 6/ 1-M - 3060762

Please be informed that the data shown in this PDF Document is generated from our Online Catalog. Please find the complete data in the user's documentation. Our General Terms of Use for Downloads are valid (<http://phoenixcontact.com/download>)



Plug, number of positions: 1, connection method: Screw connection, cross section: 0.2 mm²- 6 mm², AWG: 24 - 8, nominal current: 41 A, nom. voltage: 1000 V, width: 8.2 mm, color: gray



COMPLETE

Key Commercial Data

Packing unit	1 pc
Minimum order quantity	50 pc
GTIN	 4 046356 607964
GTIN	4046356607964
Weight per Piece (excluding packing)	7.600 g
Custom tariff number	85366990
Country of origin	China

Technical data

General

Number of positions	1
Potentials	1
Nominal cross section	6 mm ²
Color	gray
Insulating material	PA
Flammability rating according to UL 94	V0
Rated surge voltage	8 kV
Degree of pollution	3
Overvoltage category	III
Insulating material group	I

Plug - UP 6/ 1-M - 3060762

Technical data

General

Maximum power dissipation for nominal condition	1.31 W
Maximum load current	41 A (with 6 mm ² conductor cross section)
Nominal current I _N	41 A
Nominal voltage U _N	1000 V
Relative insulation material temperature index (Elec., UL 746 B)	130 °C
Temperature index of insulation material (DIN EN 60216-1 (VDE 0304-21))	125 °C
Static insulating material application in cold	-60 °C
Surface flammability NFPA 130 (ASTM E 162)	passed
Specific optical density of smoke NFPA 130 (ASTM E 662)	passed
Calorimetric heat release NFPA 130 (ASTM E 1354)	27,5 MJ/kg
Smoke gas toxicity NFPA 130 (SMP 800C)	passed
Fire protection for rail vehicles (DIN EN 45545-2) R22	HL 1 - HL 3
Fire protection for rail vehicles (DIN EN 45545-2) R23	HL 1 - HL 3
Fire protection for rail vehicles (DIN EN 45545-2) R24	HL 1 - HL 3
Fire protection for rail vehicles (DIN EN 45545-2) R26	HL 1 - HL 3

Dimensions

Width	8.2 mm
Length	21 mm
Height	42.7 mm
	26 mm
Pitch	8.2 mm

Connection data

Connection method	Screw connection
Screw thread	M3
Stripping length	10 mm
Tightening torque, min	0.6 Nm
Tightening torque max	0.8 Nm
Connection in acc. with standard	IEC 61984
Conductor cross section solid min.	0.2 mm ²
Conductor cross section solid max.	6 mm ²
Conductor cross section AWG min.	24
Conductor cross section AWG max.	8
Conductor cross section flexible min.	0.2 mm ²
Conductor cross section flexible max.	10 mm ²
Min. AWG conductor cross section, flexible	24
Max. AWG conductor cross section, flexible	8

Plug - UP 6/ 1-M - 3060762

Technical data

Connection data

Conductor cross section flexible, with ferrule without plastic sleeve min.	0.25 mm ²
Conductor cross section flexible, with ferrule without plastic sleeve max.	6 mm ²
Conductor cross section flexible, with ferrule with plastic sleeve min.	0.25 mm ²
Conductor cross section flexible, with ferrule with plastic sleeve max.	6 mm ²
2 conductors with same cross section, solid min.	0.2 mm ²
2 conductors with same cross section, solid max.	2.5 mm ²
2 conductors with same cross section, stranded min.	0.2 mm ²
2 conductors with same cross section, stranded max.	2.5 mm ²
Two conductors with the same cross section, flexible, with TWIN ferrules, with plastic sleeve, minimum	0.5 mm ²
Two conductors with the same cross section, flexible, with TWIN ferrules, with plastic sleeve, maximum	4 mm ²
Two conductors with the same cross section stranded, with ferrule and without plastic sleeve, minimum	0.25 mm ²
Two conductors with the same cross section stranded, with ferrule and without plastic sleeve, maximum	1.5 mm ²
Internal cylindrical gage	A5

Standards and Regulations

Connection in acc. with standard	IEC 61984
Flammability rating according to UL 94	V0

Environmental Product Compliance

REACH SVHC	Lead 7439-92-1
China RoHS	Environmentally Friendly Use Period = 50 years
	For details about hazardous substances go to tab "Downloads", Category "Manufacturer's declaration"

Drawings

Plug - UP 6/ 1-M - 3060762

Schematic diagram

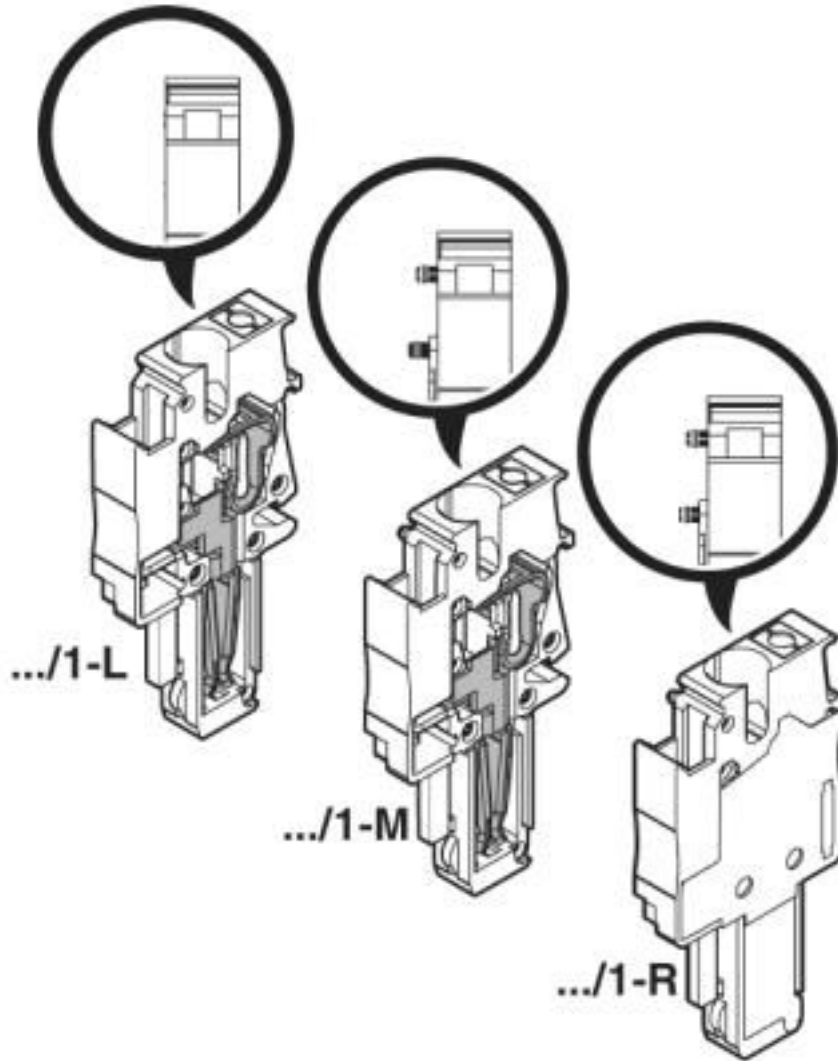

Circuit diagram



Classifications

eCl@ss

eCl@ss 10.0.1	27141151
---------------	----------

Plug - UP 6/ 1-M - 3060762

Classifications

eCl@ss

eCl@ss 4.0	27260700
eCl@ss 4.1	27260700
eCl@ss 5.0	27260700
eCl@ss 5.1	27260700
eCl@ss 6.0	27141100
eCl@ss 7.0	27141151
eCl@ss 8.0	27141151
eCl@ss 9.0	27141151

ETIM

ETIM 4.0	EC002021
ETIM 5.0	EC002021
ETIM 6.0	EC002021
ETIM 7.0	EC002021

UNSPSC

UNSPSC 6.01	30211802
UNSPSC 7.0901	39121402
UNSPSC 11	39121402
UNSPSC 12.01	39121402
UNSPSC 13.2	39121402
UNSPSC 18.0	39121402
UNSPSC 19.0	39121402
UNSPSC 20.0	39121402
UNSPSC 21.0	39121402

Approvals

Approvals

Approvals

CSA / UL Recognized / cUL Recognized / IECCE CB Scheme / VDE Gutachten mit Fertigungsüberwachung / EAC / EAC / cULus Recognized

Ex Approvals

Approval details

Plug - UP 6/ 1-M - 3060762

Approvals

CSA		http://www.csagroup.org/services-industries/product-listing/	13631
	B	C	
Nominal voltage UN	600 V	600 V	
Nominal current IN	50 A	50 A	
mm ² /AWG/kcmil	24-8	24-8	

UL Recognized		http://database.ul.com/cgi-bin/XYV/template/LISEXT/1FRAME/index.htm	FILE E 60425
	B	C	
Nominal voltage UN	600 V	600 V	
Nominal current IN	40 A	40 A	
mm ² /AWG/kcmil	24-8	24-8	

cUL Recognized		http://database.ul.com/cgi-bin/XYV/template/LISEXT/1FRAME/index.htm	FILE E 60425
	B	C	
Nominal voltage UN	600 V	600 V	
Nominal current IN	40 A	40 A	
mm ² /AWG/kcmil	24-8	24-8	

IECEE CB Scheme		http://www.iecee.org/	DE1-60929
Nominal voltage UN	1000 V		
Nominal current IN	41 A		
mm ² /AWG/kcmil	0.2-6		

VDE Gutachten mit Fertigungsüberwachung		http://www2.vde.com/de/Institut/Online-Service/VDE-gepruefteProdukte/Seiten/Online-Suche.aspx	40034876
Nominal voltage UN	1000 V		
Nominal current IN	41 A		

Plug - UP 6/ 1-M - 3060762

Approvals

mm²/AWG/kcmil	0.2-6
---------------	-------

EAC		RU C- DE.A*30.B.01742
-----	--	--------------------------

EAC		RU C- DE.BL08.B.00511
-----	--	--------------------------

cULus Recognized		
------------------	--	--

Accessories

Accessories

End cover

Flange cover - DF-UP 6 - 3060856



Flange cover, snap onto the UP 6/... plugs, length: 21 mm, width: 4.5 mm, height: 24.7 mm, color: gray

Insulating sleeve

Insulating sleeve - MPS-IH WH - 0201663

Insulating sleeve, color: white



Plug - UP 6/ 1-M - 3060762

Accessories

Insulating sleeve - MPS-IH RD - 0201676

Insulating sleeve, color: red



Insulating sleeve - MPS-IH BU - 0201689

Insulating sleeve, color: blue



Insulating sleeve - MPS-IH YE - 0201692

Insulating sleeve, color: yellow



Insulating sleeve - MPS-IH GN - 0201702

Insulating sleeve, color: green



Insulating sleeve - MPS-IH GY - 0201728

Insulating sleeve, color: gray



Plug - UP 6/ 1-M - 3060762

Accessories

Insulating sleeve - MPS-IH BK - 0201731

Insulating sleeve, color: black



Labeled terminal marker

Zack Marker strip, flat - ZBF 8 CUS - 0825030



Zack Marker strip, flat, can be ordered: Strip, white, labeled according to customer specifications, mounting type: snap into flat marker groove, for terminal block width: 8 mm, lettering field size: 5.15 x 8.15 mm, Number of individual labels: 10

Zack Marker strip, flat - ZBF 8,LGS:FORTL.ZAHLEN - 0808804



Zack Marker strip, flat, Strip, white, labeled, printed horizontally: consecutive numbers 1 ... 10, 11 ... 20, etc. up to 101 ... 110, mounting type: snap into flat marker groove, for terminal block width: 8 mm, lettering field size: 5.15 x 8.15 mm, Number of individual labels: 10

Marker for terminal blocks - UC-TMF 8 CUS - 0824654



Marker for terminal blocks, can be ordered: by sheet, white, labeled according to customer specifications, mounting type: snap into flat marker groove, for terminal block width: 8.2 mm, lettering field size: 7.6 x 5.1 mm, Number of individual labels: 56

Marker for terminal blocks - UCT-TMF 8 CUS - 0829672



Marker for terminal blocks, can be ordered: by sheet, white, labeled according to customer specifications, mounting type: snap into flat marker groove, for terminal block width: 8.2 mm, lettering field size: 7.4 x 4.7 mm, Number of individual labels: 42

Plug - UP 6/ 1-M - 3060762

Accessories

Mounting material

Latching - PRZ - 3040614



Latching, length: 63.6 mm, width: 9.7 mm, number of positions: 2, color: orange

Latching - PR - 3040559



Latching, length: 29.8 mm, width: 4.4 mm, number of positions: 1, color: orange

Latching - PR/2 - 3040630



Latching, length: 29.8 mm, width: 10 mm, number of positions: 2, color: orange

Latching - PRT/2 - 3040631



Latching, can only be released using a screwdriver, length: 23.2 mm, width: 9 mm, number of positions: 2, color: orange

Screwdriver tools

Screwdriver - SZS 1,0X4,0 VDE - 1205066



Screwdriver, slot-headed, VDE insulated, size: 1.0 x 4.0 x 100 mm, 2-component grip, with non-slip grip

Plug - UP 6/ 1-M - 3060762

Accessories

Screwdriver - SF-SL 0,6X3,5-100 S-VDE - 1212587



Actuation tool, for ST terminal blocks, VDE insulated, with slimmer insulation integrated in the blade, also suitable for use as a bladed screwdriver, size: 0.6 x 3.5 x 100 mm, 2-component grip, with non-slip grip

Shield connection

Shield connection clamp - PSH 3- 6 - 3040591



Shield connection clamp, color: black

Shield connection clamp - PSH 5-10 - 3040601



Shield connection clamp, color: black

Strain relief

Strain relief - PZ/2 - 3040627



Strain relief, length: 48.7 mm, width: 9.3 mm, number of positions: 2, color: black

Terminal marking

Plug - UP 6/ 1-M - 3060762

Accessories

Zack Marker strip, flat - ZBF 8:UNBEDRUCKT - 0808781



Zack Marker strip, flat, Strip, white, unlabeled, can be labeled with: PLOTMARK, CMS-P1-PLOTTER, mounting type: snap into flat marker groove, for terminal block width: 8 mm, lettering field size: 5.15 x 8.15 mm, Number of individual labels: 10

Marker for terminal blocks - UC-TMF 8 - 0818137



Marker for terminal blocks, Sheet, white, unlabeled, can be labeled with: BLUEMARK ID COLOR, BLUEMARK ID, BLUEMARK CLED, PLOTMARK, CMS-P1-PLOTTER, mounting type: snap into flat marker groove, for terminal block width: 8.2 mm, lettering field size: 7.6 x 5.1 mm, Number of individual labels: 56

Marker for terminal blocks - UCT-TMF 8 - 0828748



Marker for terminal blocks, Sheet, white, unlabeled, can be labeled with: TOPMARK NEO, TOPMARK LASER, BLUEMARK ID COLOR, BLUEMARK ID, BLUEMARK CLED, THERMOMARK PRIME, THERMOMARK CARD 2.0, THERMOMARK CARD, mounting type: snap into flat marker groove, for terminal block width: 8.2 mm, lettering field size: 7.4 x 4.7 mm, Number of individual labels: 42

Test plug terminal block

Test plugs - MPS-MT - 0201744



Test plugs, with solder connection up to 1 mm² conductor cross section, color: gray