

EMC filter surge protection device - SFP 1-10/120AC - 2920670

Please be informed that the data shown in this PDF Document is generated from our Online Catalog. Please find the complete data in the user's documentation. Our General Terms of Use for Downloads are valid (<http://phoenixcontact.com/download>)



Device protection, according to type 3/class III, with network interference suppression filter to prevent high-frequency interference voltages, for 1-phase power supply networks with separate N and PE (3-conductor system: L1, N, PE), with remote indication contact.

Product Description

Device protection with interference filter

Your advantages

- ✓ Can be installed in industrial environments
- ✓ Combined protective circuit for absorbing transient surge voltages and high-frequency interference voltages
- ✓ Thermal monitoring of the protective circuit
- ✓ Disconnection status signaled via floating remote indication contact
- ✓ Integrated power display switches off automatically when there is a malfunction due to overload.



Key Commercial Data

Packing unit	1 pc
GTIN	 4 046356 158480
GTIN	4046356158480
Weight per Piece (excluding packing)	608.600 g
Custom tariff number	85363010
Country of origin	Germany

Technical data

Dimensions

Height	86.6 mm
Width	112 mm
Depth	79 mm

EMC filter surge protection device - SFP 1-10/120AC - 2920670

Technical data

Ambient conditions

Degree of protection	IP20
Ambient temperature (operation)	-25 °C ... 70 °C
Ambient temperature (storage/transport)	-25 °C ... 70 °C
Permissible humidity (operation)	5 % ... 95 %

General

EN type	T3
Number of ports	Two
Mode of protection	L-N
	L-PE
	N-PE
Mounting type	DIN rail: 35 mm
Color	black
	silver
Housing material	Aluminum
Degree of pollution	2
Flammability rating according to UL 94	V-0
Type	DIN rail module, one-piece
Number of positions	2
Surge protection fault message	Optical, remote indicator contact
For country-specific use in	USA, CN, BR

Protective circuit

Nominal voltage U_N	120 V AC (TN)
	120 V AC (TT - only in use with RCD)
	120 V AC (IT)
Nominal frequency f_N	50 Hz (60 Hz)
Maximum continuous voltage U_C	150 V AC
Rated load current I_L	10 A (60 °C)
Residual current I_{PE}	≤ 0.6 mA
Nominal discharge current I_n (8/20) μ s	3 kA
Standby power consumption P_C	≤ 7.5 VA (at U_{REF})
	≤ 10 VA (at U_C)
Reference test voltage U_{REF}	132 V AC
Combination wave U_{OC}	6 kV (3 kA)
Voltage protection level U_p	≤ 0.45 kV
TOV behavior at U_T (L-N)	175 V AC (5 s / withstand mode)
	240 V AC (5 s / safe failure mode)

EMC filter surge protection device - SFP 1-10/120AC - 2920670

Technical data

Protective circuit

	208 V AC (120 min / safe failure mode)
TOV behavior at U_T (L-PE)	208 V AC (5 s / withstand mode)
	175 V AC (120 min / withstand mode)
	1332 V AC (200 ms / safe failure mode)
TOV behavior at U_T (N-PE)	1200 V AC (200 ms / safe failure mode)
Response time t_A	≤ 25 ns
Capacity (L-N)	1 μ F ± 10 %
	10 nF ± 10 % (X2-275 V)
Capacity (L-PE)	2.2 nF ± 20 % (Y2-250 V)
Capacity (L-PEN)	2.2 nF ± 20 % (Y2-250 V)
Max. required back-up fuse	20 A (MCB B/general purpose)
	16 A (IT - MCB B/general purpose)
Input attenuation aE, sym.	20 dB (≥ 100 kHz / 50 Ω)
Input attenuation aE, asym.	30 dB (≥ 1 MHz / 50 Ω)
Short-circuit current rating I_{SCCR}	5 kA AC (TN/TT)
	1 kA AC (IT)

Indicator/remote signaling

Switching function	PDT contact
Operating voltage	12 V AC ... 250 V AC
	250 V DC (250 mA DC)
Operating current	100 mA AC ... 1 A AC
	1 A DC (48 V DC)
Connection method	Pluggable screw connection
Conductor cross section flexible	0.14 mm ² ... 1.5 mm ²
Conductor cross section solid	0.14 mm ² ... 1.5 mm ²
Conductor cross section AWG	26 ... 16
Screw thread	M2
Tightening torque	0.25 Nm
Stripping length	7 mm

Connection data

Connection method	Screw terminal blocks
Conductor cross section flexible	2.5 mm ² ... 4 mm ²
Conductor cross section solid	2.5 mm ² ... 6 mm ²
Conductor cross section AWG	14 ... 10
Screw thread	M3
Tightening torque	0.5 Nm ... 0.6 Nm

EMC filter surge protection device - SFP 1-10/120AC - 2920670

Technical data

Connection data

	4.5 lb _f -in. ... 5.5 lb _f -in.
Stripping length	8 mm

UL specifications

SPD Type	2CA
Maximum continuous operating voltage MCOV (L-N)	150 V AC
Maximum continuous operating voltage MCOV (L-G)	150 V AC
Maximum continuous operating voltage MCOV (N-G)	150 V AC
Mode of protection	L-N
	L-G
	N-G
Power distribution system	Single phase
Nominal frequency	50/60 Hz
Voltage protection rating VPR (L-N)	500 V
Voltage protection rating VPR (L-G)	500 V
Voltage protection rating VPR (N-G)	500 V
Nominal discharge current I _n	3 kA
Short-circuit current rating (SCCR)	5 kA

Protective circuit, filter

Discharge resistance	820 kΩ
----------------------	--------

Environmental Product Compliance

China RoHS	Environmentally Friendly Use Period = 50 years
	For details about hazardous substances go to tab "Downloads", Category "Manufacturer's declaration"

Drawings

EMC filter surge protection device - SFP 1-10/120AC - 2920670

Diagram

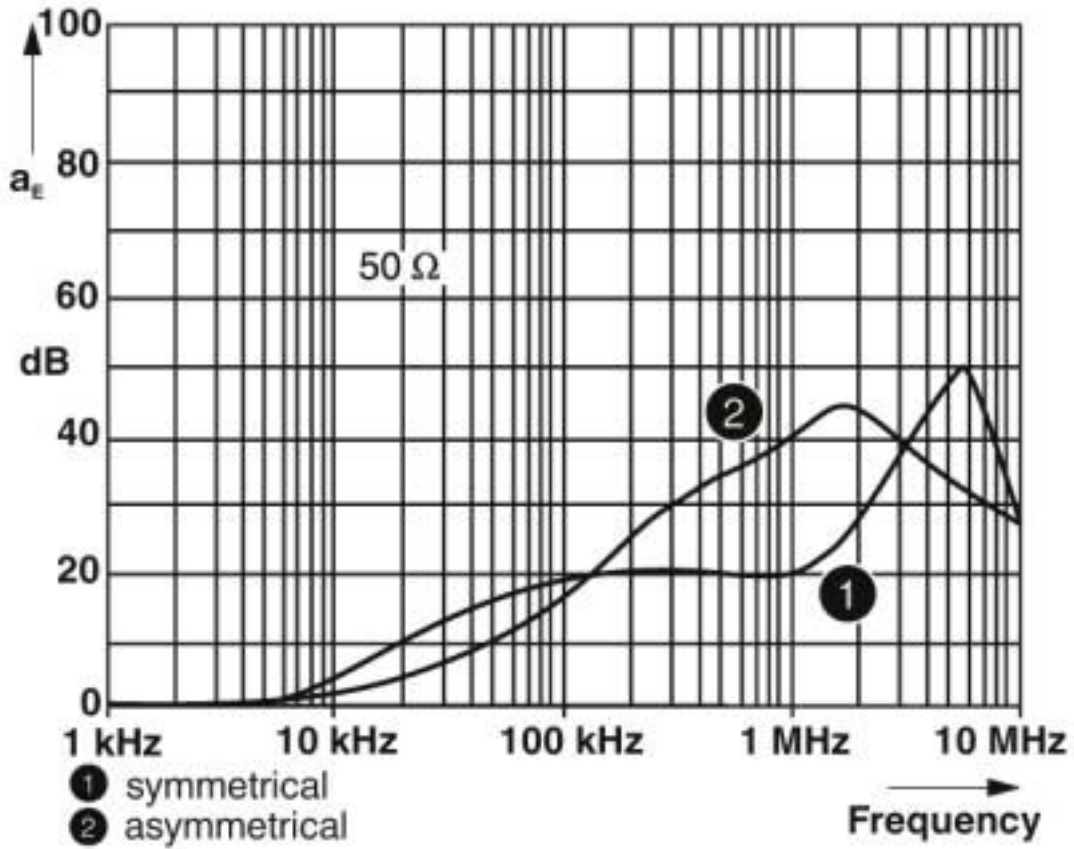

Diagram

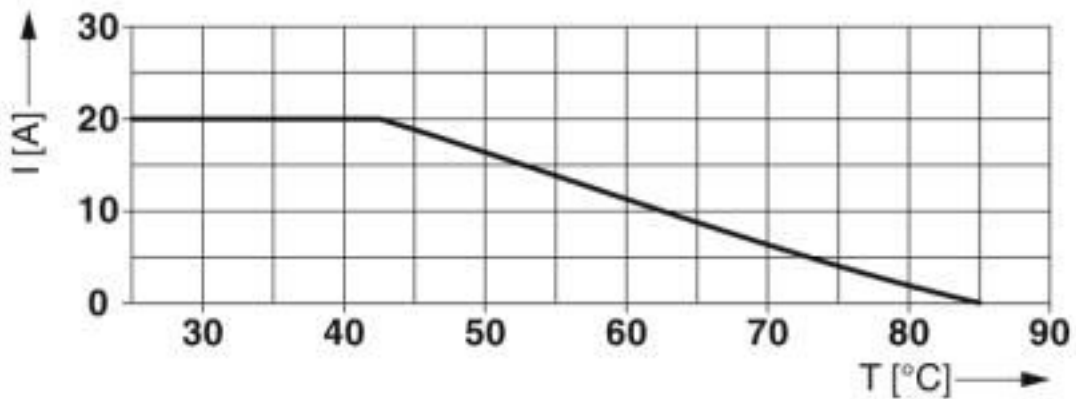

EMC filter surge protection device - SFP 1-10/120AC - 2920670

Dimensional drawing

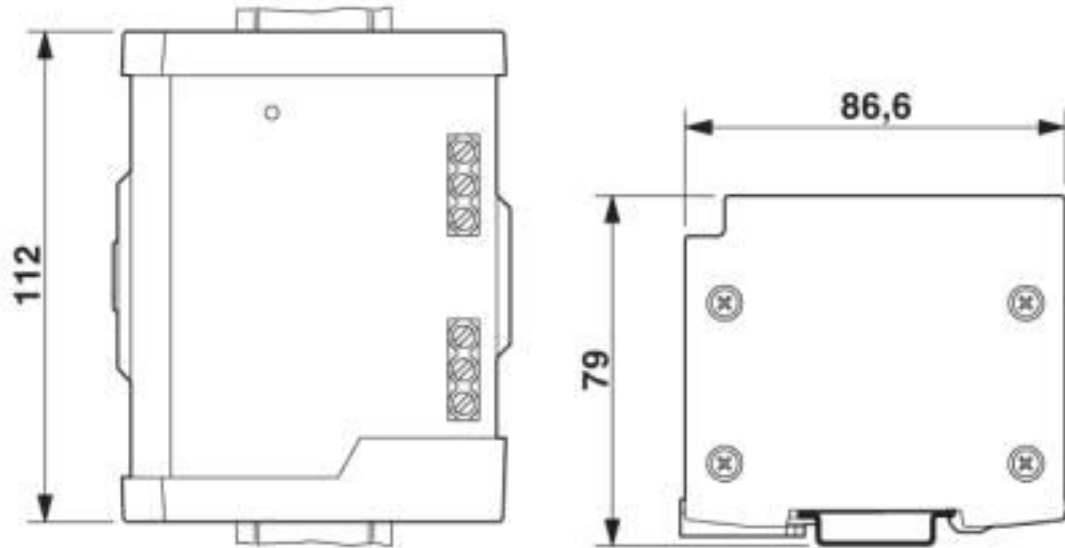

Circuit diagram

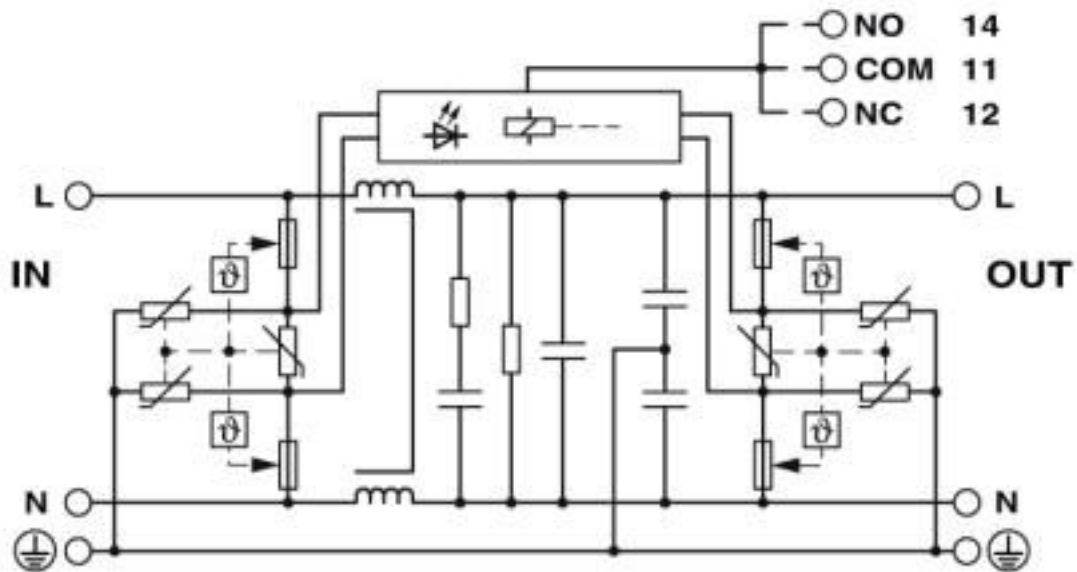

Classifications

eCl@ss

eCl@ss 10.0.1	27130806
eCl@ss 4.0	27130800
eCl@ss 4.1	27130800

EMC filter surge protection device - SFP 1-10/120AC - 2920670

Classifications

eCl@ss

eCl@ss 5.0	27130800
eCl@ss 5.1	27130800
eCl@ss 6.0	27130800
eCl@ss 7.0	27130806
eCl@ss 8.0	27130806
eCl@ss 9.0	27130806

ETIM

ETIM 2.0	EC000942
ETIM 3.0	EC000942
ETIM 4.0	EC000942
ETIM 5.0	EC000942
ETIM 6.0	EC000942
ETIM 7.0	EC000942

UNSPSC

UNSPSC 6.01	30212010
UNSPSC 7.0901	39121610
UNSPSC 11	39121610
UNSPSC 12.01	39121610
UNSPSC 13.2	39121620
UNSPSC 18.0	39121620
UNSPSC 19.0	39121620
UNSPSC 20.0	39121620
UNSPSC 21.0	39121620

Approvals

Approvals

Approvals





CSA / UL Recognized / cUL Recognized / CSAus / EAC / cULus Recognized

Ex Approvals

Approval details

EMC filter surge protection device - SFP 1-10/120AC - 2920670

Approvals

CSA		http://www.csagroup.org/services-industries/product-listing/	70205391
UL Recognized		http://database.ul.com/cgi-bin/XYV/template/LISEXT/1FRAME/index.htm	FILE E 330181
cUL Recognized		http://database.ul.com/cgi-bin/XYV/template/LISEXT/1FRAME/index.htm	FILE E 330181
CSAus		http://www.csagroup.org/services-industries/product-listing/	70205391
EAC			RU C- DE.A*30.B01561
cULus Recognized	