

DC/DC converters - QUINT4-PS/24DC/24DC/10/PT - 2910120

Please be informed that the data shown in this PDF Document is generated from our Online Catalog. Please find the complete data in the user's documentation. Our General Terms of Use for Downloads are valid (<http://phoenixcontact.com/download>)



Primary-switched QUINT DC/DC converter for DIN rail mounting with SFB (Selective Fuse Breaking) Technology, Push-in connection, input: 24 V DC, output: 24 V DC / 10 A

Product Description

QUINT DC/DC converter with maximum functionality

DC/DC converters alter the voltage level, regenerate the voltage at the end of long cables or enable the creation of independent supply systems by means of electrical isolation.

QUINT DC/DC converters magnetically and therefore quickly trip circuit breakers with six times the nominal current, for selective and therefore cost-effective system protection. The high level of system availability is additionally ensured, thanks to preventive function monitoring, as it reports critical operating states before errors occur.

Your advantages

- ✓ Most powerful output side: easy system expansion, reliable heavy load startup and miniature circuit breaker tripping
- ✓ Most comprehensive signaling: preventive function monitoring reports critical operating states before errors occur
- ✓ Free selection between Push-in and screw connection
- ✓ Available pre-configured: from a batch quantity of just 1



Key Commercial Data

Packing unit	1 pc
GTIN	 4 055626 537498
GTIN	4055626537498
Weight per Piece (excluding packing)	1,040.000 g
Custom tariff number	85044030
Country of origin	Thailand

Technical data

Input data

Input voltage range	24 V DC -25 % ... +40 %
---------------------	-------------------------

DC/DC converters - QUINT4-PS/24DC/24DC/10/PT - 2910120

Technical data

Input data

Electric strength, max.	35 V DC (60 s)
Typical current consumption	13.8 A (24 V DC)
Mains buffering	typ. 11 ms (24 V DC)
Switch-on time	< 1 s
Typical response time	300 ms (from SLEEP MODE)
Inrush current limitation typical	1.5 A (after 1 ms)
Inrush current integral (I^2t)	< 0.02 A ² s
Input fuse	30 A (slow-blow, internal)

Insulation electric strength

Insulation voltage input/output	4 kV DC (type test)
	2 kV DC (routine test)
Type test (IEC/EN 60950-1) A	2 kV DC
Type test (IEC/EN 60950-1) B	4 kV DC
Type test (IEC/EN 60950-1) C	0.5 kV DC
Type test (IEC/EN 60950-1) D	0.5 kV DC
Production test A	2 kV DC
Production test B	2 kV DC
Production test C	0.5 kV DC
Production test D	0.5 kV DC

Input connection data

Connection method	Push-in connection
Stripping length	10 mm
Conductor cross section solid	0.2 mm ² ... 6 mm ²
Conductor cross section flexible	0.2 mm ² ... 6 mm ²
Flexible conductor cross section (ferrule with plastic sleeve)	0.2 mm ² ... 4 mm ²
Flexible conductor cross section flexible (ferrule, w/o plastic sleeve)	0.2 mm ² ... 4 mm ²
Conductor cross section AWG	24 ... 10

Output data

Nominal output voltage (U_N)	24 V DC
Setting range of the output voltage (U_{Set})	24 V DC ... 29.5 V DC (> 24 V DC, constant capacity)
Nominal output current (I_N)	10 A
Static Boost ($I_{Stat.Boost}$)	12.5 A
Dynamic Boost ($I_{Dyn.Boost}$)	20 A (5 s)
Selective Fuse Breaking (I_{SFB})	60 A (15 ms)
Magnetic circuit breaker tripping	A1...A6 / B2...B6 / C1...C3 / Z1...Z6

DC/DC converters - QUINT4-PS/24DC/24DC/10/PT - 2910120

Technical data

Output data

System deviation, static	< 1 % (change in load, static 10 % ... 90 %)
System deviation, dynamic	< 3 % (Dynamic load change 10 % ... 90 %, 10 Hz)
System deviation, input voltage change	< 0.1 % (change in input voltage ± 10 %)
Short-circuit-proof	yes
No-load proof	yes
Residual ripple	< 50 mV _{PP}
Connection in parallel	Yes, for redundancy and increased capacity
Connection in series	yes
Feedback voltage resistance	≤ 35 V DC
Protection against overvoltage at the output (OVP)	≤ 32 V DC
Rise time	< 1 s (U_{OUT} (10 % ... 90 %))

Output connection data

Connection method	Push-in connection
Stripping length	10 mm
Conductor cross section solid	0.2 mm ² ... 6 mm ²
Conductor cross section flexible	0.2 mm ² ... 6 mm ²
Flexible conductor cross section (ferrule with plastic sleeve)	0.2 mm ² ... 4 mm ²
Flexible conductor cross section flexible (ferrule, w/o plastic sleeve)	0.2 mm ² ... 4 mm ²
Conductor cross section AWG	24 ... 10

LED signaling

Types of signaling	LED
	Floating signal contact
	Active signal output Out1 (digital, configurable)
	Active signal output Out2 (analog, configurable)
	Remote contact
	Signal ground SGnd
P_{Out}	> 100 % (LED lights up yellow, output power > 240 W)
	> 75 % (LED lights up green, output power > 180 W)
	> 50 % (LED lights up green, output power > 120 W)
U_{Out}	> 0.9 x U_{Set} (LED lights up green)
	< 0.9 x U_{Set} (LED flashes green)
U_{In}	> 0.8 x U_{InNom} (LED off)
	< 0.8 x U_{InNom} (LED lights up yellow)

Signal contacts – signal output Out 1 (configurable)

Connection labeling	3.5 +
Digital	0 V DC

DC/DC converters - QUINT4-PS/24DC/24DC/10/PT - 2910120

Technical data

Signal contacts – signal output Out 1 (configurable)

	24 V DC
	20 mA
Default	U _{IN} input voltage OK
Signal option	Output voltage
	Output current
	Output power
	Operating hours
	Early warning of high temperatures
	OVP voltage limitation active

Signal contacts – signal output Out 2 (configurable)

Connection labeling	3.6 +
Digital	0 V DC
	24 V DC
	20 mA
Default	Output power
Signal option	Output voltage
	Output current
	Operating hours
	Early warning of high temperatures
	OVP voltage limitation active
Analog	4 mA ... 20 mA ±5 % (Load ≤400 #)
Signal option	Output voltage
	Output current
	Output power

Signal contacts – signal output relay 13/14 (configurable)

Connection labeling	3.1, 3.2
Switch contact	floating
Maximum contact load	24 V DC
	1 A
	30 V AC
	0.5 A
Default	Output voltage
Signal option	Output current
	Output power
	Operating hours
	Early warning of high temperatures

DC/DC converters - QUINT4-PS/24DC/24DC/10/PT - 2910120

Technical data

Signal contacts – signal output relay 13/14 (configurable)

	OVP voltage limitation active
	U _{IN} input voltage OK

Signal contacts – remote signal input (configurable)

Connection labeling	3.3 +
Function	Output power ON/OFF (remote)
Default	Output power ON (>40 kΩ/24 V DC/open bridge between REM and SGnd)

Signal contacts – signal ground SGnd

Connection labeling	3.4 +
Function	Signal ground
Reference potential	to OUT1, OUT2, REM

Signal connection data

Connection method	Push-in connection
Conductor cross section solid	0.2 mm ² ... 1 mm ²
Conductor cross section flexible	0.2 mm ² ... 1.5 mm ²
Flexible conductor cross section (ferrule with plastic sleeve)	0.2 mm ² ... 0.75 mm ²
Flexible conductor cross section flexible (ferrule, w/o plastic sleeve)	0.2 mm ² ... 1.5 mm ²
Conductor cross section AWG	24 ... 16
Stripping length	8 mm

Reliability

MTBF (IEC 61709, SN 29500)	> 1380000 h (25 °C)
	> 800000 h (40 °C)
	> 340000 h (60 °C)

Life expectancy (electrolytic capacitors)

Output current	5 A
Temperature	40 °C
Time	367721 h
Voltage	24 V DC
Output current	10 A
Temperature	40 °C
Time	183860 h
Voltage	24 V DC
Output current	10 A
Temperature	30 °C
Time	422400 h
Voltage	24 V DC

DC/DC converters - QUINT4-PS/24DC/24DC/10/PT - 2910120

Technical data

Switching frequency

Auxiliary converter stage	190 kHz ... 220 kHz ()
Main converter stage	67 kHz ... 135 kHz ()

General data

Degree of protection	IP20
Protection class	Special with SELV input and output
Inflammability class in acc. with UL 94 (housing / terminal blocks)	V0
Side element version	Aluminum
Hood version	Stainless steel X6Cr17
Width	50 mm
Height	130 mm
Depth	125 mm
Width with alternative assembly	122 mm
Height with alternative assembly	130 mm
Depth with alternative assembly	53 mm
Weight	0.8 kg
Efficiency	typ. 93.3 % (24 V DC)

Power dissipation

Maximum power dissipation in no-load condition	< 5 W
Power dissipation SLEEP MODE	< 2 W
Power loss nominal load max.	< 16 W

Ambient conditions

Ambient temperature (operation)	-25 °C ... 70 °C (> 60 °C Derating: 2.5 %/K)
Ambient temperature (start-up type tested)	-40 °C
Ambient temperature (storage/transport)	-40 °C ... 85 °C
Max. permissible relative humidity (operation)	≤ 95 % (at 25 °C, non-condensing)
Maximum altitude	≤ 5000 mm (> 2000 m, observe derating)
Vibration (operation)	5 Hz ... 100 Hz resonance search 2.3g, 90 min., resonance frequency 2.3g, 90 min. (according to DNV GL Class C)
Shock	18 ms, 30g, in each space direction (according to IEC 60068-2-27)
Degree of pollution	2
Climatic class	3K3 (EN 60721)
Overvoltage category EN 61010-1	II
Overvoltage category EN 62477-1	III

Standards

EMC requirements for noise immunity	EN 61000-6-1
	EN 61000-6-2

DC/DC converters - QUINT4-PS/24DC/24DC/10/PT - 2910120

Technical data

Standards

EMC requirements for noise emission	EN 61000-6-3
	EN 61000-6-4
EMC requirements, power plant	IEC 61850-3
	EN 61000-6-5
Standard designation	Electrical safety (of control and regulation devices)
Standards/regulations	IEC 61010-1
Standard designation	Safety extra-low voltage
Standards/regulations	EN 61010-1 (SELV)
	IEC 61010-2-201 (PELV)
Standard designation	Explosive atmospheres
Standards/regulations	IEC 60079-0
	IEC 60079-7
	IEC 60079-11
	IEC 60079-15
Standard designation	Mains variation/undervoltage
Standards/regulations	EN 61000-4-29

Conformance/approvals

Designation	UL
Identification	UL Listed UL 61010-1
Designation	UL
Identification	UL Listed UL 61010-2-201
Designation	UL
Identification	UL ANSI/ISA-12.12.01 Class I, Division 2, Groups A, B, C, D T4 (Hazardous Location)
Designation	CSA
Identification	CAN/CSA-C22.2 No. 61010-1-12
Designation	CSA
Identification	CAN/CSA-IEC 61010-2-201:14
Designation	SIQ
Identification	Type tested (type approved)
Designation	SIQ
Identification	CB scheme (IEC 61010-1, IEC 61010-2-201)
Designation	Shipbuilding
Identification	DNV GL
Designation	Shipbuilding
Identification	ABS
Designation	ATEX

DC/DC converters - QUINT4-PS/24DC/24DC/10/PT - 2910120

Technical data

Conformance/approvals

Identification	# II 3 G Ex ec ic nC IIC T4 Gc X
Designation	IECEX
Identification	IECEX SIQ 19.0001X
	Ex ec ic nC IIC T4 Gc

EMC data

Electromagnetic compatibility	Conformance with EMC Directive 2014/30/EU
Low Voltage Directive	Conformance with Low Voltage Directive 2014/35/EC
Conducted noise emission	EN 55016
	EN 61000-6-3 (Class B)
Noise emission	EN 55016
	EN 61000-6-3 (Class B)
DNV GL conducted interference	Class B
Additional text	Bridge and deck area
DNV GL noise radiation	Class B
Additional text	Bridge and deck area
Electrostatic discharge	EN 61000-4-2
Contact discharge	8 kV (Test Level 4)
Discharge in air	15 kV (Test Level 4)
Electromagnetic HF field	EN 61000-4-3
Frequency range	80 MHz ... 1 GHz
Test field strength	20 V/m (Test Level 3)
Frequency range	1 GHz ... 6 GHz
Test field strength	10 V/m (Test Level 3)
Frequency range	1 GHz ... 6 GHz
Test field strength	10 V/m (Test Level 3)
Comments	Criterion A
Fast transients (burst)	EN 61000-4-4
Input	2 kV (Test Level 3 - asymmetrical)
Output	2 kV (Test Level 3 - asymmetrical)
Signal	2 kV (Test Level 4 - asymmetrical)
Comments	Criterion A
Surge voltage load (surge)	EN 61000-4-5
Input	1 kV (Test Level 3 - symmetrical)
	2 kV (Test Level 3 - asymmetrical)
Output	1 kV (Test Level 3 - symmetrical)
	2 kV (Test Level 3 - asymmetrical)
Signal	2 kV (Test Level 3 - asymmetrical)

DC/DC converters - QUINT4-PS/24DC/24DC/10/PT - 2910120

Technical data

EMC data

Comments	Criterion A
Conducted interference	EN 61000-4-6
I/O/S	asymmetrical
Frequency range	0.15 MHz ... 80 MHz
Voltage	10 V (Test Level 3)
Comments	Criterion A
Power frequency magnetic field	EN 61000-4-8
Frequency	16.7 Hz
	50 Hz
	60 Hz
Test field strength	100 A/m
Additional text	60 s
Comments	Criterion A
Frequency	50 Hz
	60 Hz
Frequency range	50 Hz ... 60 Hz
Test field strength	1 kA/m
Additional text	3 s
Comments	Criterion A
Frequency	0 Hz
Test field strength	300 A/m
Additional text	DC, 60 s
Comments	Criterion A
Voltage dips	EN 61000-4-29
Voltage	24 V DC
Voltage dip	70 %
Additional text	Test Level 2
Comments	Criterion A
Voltage dip	40 %
Additional text	Test Level 2
Comments	Criterion B
Voltage dip	0 %
Additional text	Test Level 2
Comments	Criterion B
Pulse-shape magnetic field	EN 61000-4-9
Test field strength	1000 A/m
Comments	Criterion A

DC/DC converters - QUINT4-PS/24DC/24DC/10/PT - 2910120

Technical data

EMC data

Damped oscillating magnetic field	EN 61000-4-10
Test field strength	100 A/m
Test level 1	100 kHz
Test field strength	100 A/m
Test level 2	1 MHz
Comments	Criterion A
Asymmetrical conducted disturbance variables	EN 61000-4-16
Test level 1	15 Hz 150 Hz (Test Level 3)
Voltage	10 V 1 V
Test level 2	150 Hz 1.5 kHz (Test Level 3)
Voltage	1 V
Test level 3	1.5 kHz 15 kHz (Test Level 3)
Voltage	1 V 10 V
Test level 4	15 kHz 150 kHz (Test Level 3)
Voltage	10 V
Test level 5	16.7 Hz 50 Hz 60 Hz 150 Hz 180 Hz (Test Level 3)
Voltage	10 V (Permanent)
Test level 6	0 Hz 16.7 Hz 50 Hz 60 Hz (Test Level 3)
Voltage	100 V (1 s)
Comments	Criterion A
Alternating component of DC voltage	EN 61000-4-17
Attenuated oscillating wave	EN 61000-4-18
Input, output (test level 1)	100 kHz 1 MHz (Test Level 2 - symmetrical)
Voltage	0.5 kV
Input, output (test level 2)	100 kHz 1 MHz (Test Level 2 - asymmetrical)
Voltage	1 kV
Input, output (test level 3)	10 MHz (Test Level 2 - asymmetrical)
Voltage	0.5 kV
Signals (test level 1)	100 kHz 1 MHz (Test Level 2 - symmetrical)
Voltage	0.5 kV
Signals (test level 2)	100 kHz 1 MHz (Test Level 2 - asymmetrical)
Voltage	1 kV
Comments	Criterion A
Criterion A	Normal operating behavior within the specified limits.
Criterion B	Temporary impairment to operational behavior that is corrected by the device itself.

DC/DC converters - QUINT4-PS/24DC/24DC/10/PT - 2910120

Technical data

EMC data

Criterion C	Temporary adverse effects on the operating behavior, which the device corrects automatically or which can be restored by actuating the operating elements.
-------------	--

Drawings

Schematic diagram

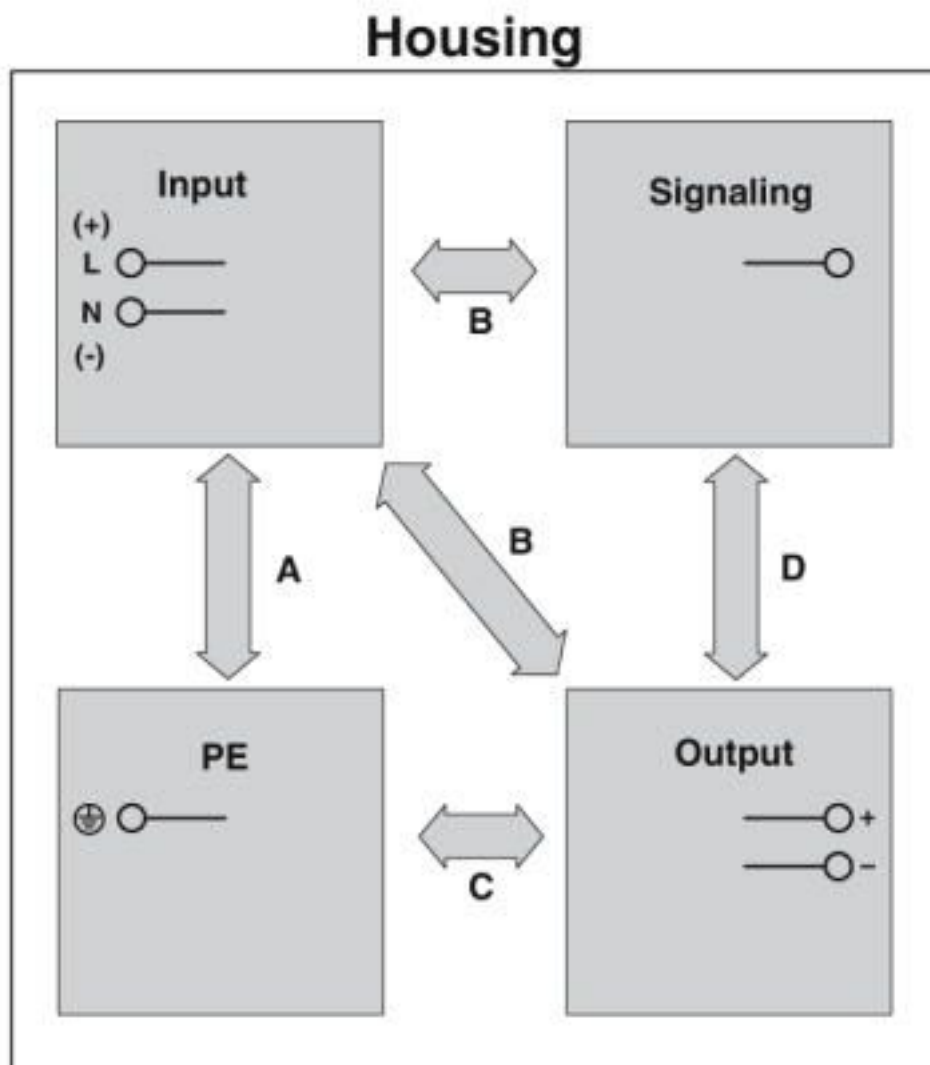

DC/DC converters - QUINT4-PS/24DC/24DC/10/PT - 2910120

Block diagram

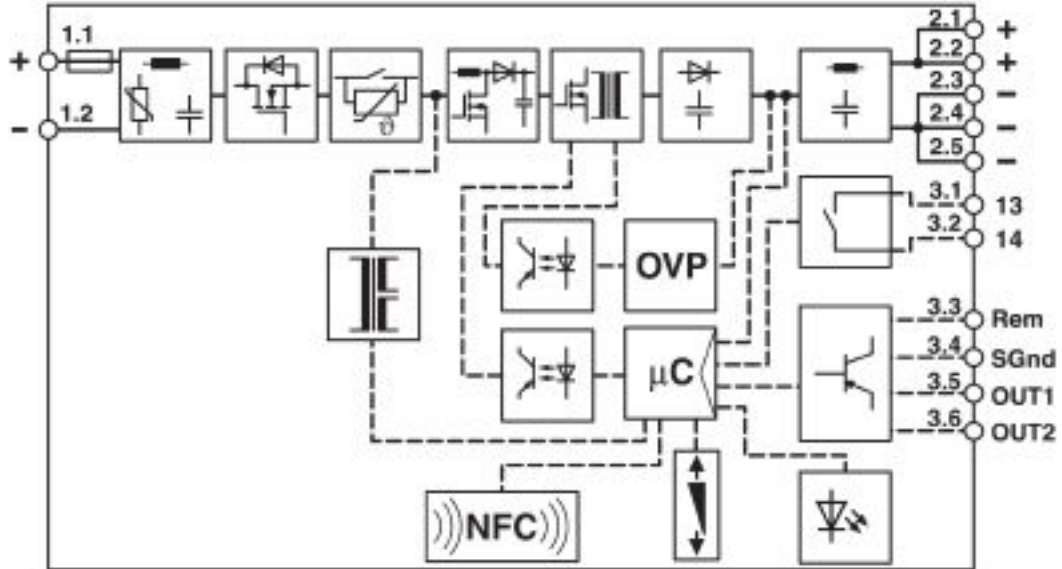

Diagram

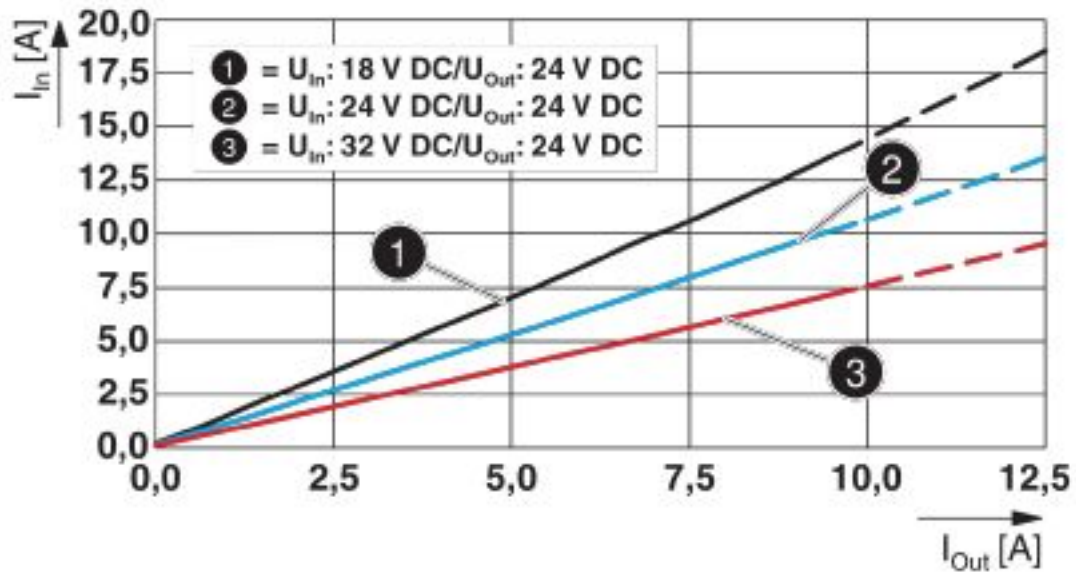

DC/DC converters - QUINT4-PS/24DC/24DC/10/PT - 2910120

Diagram

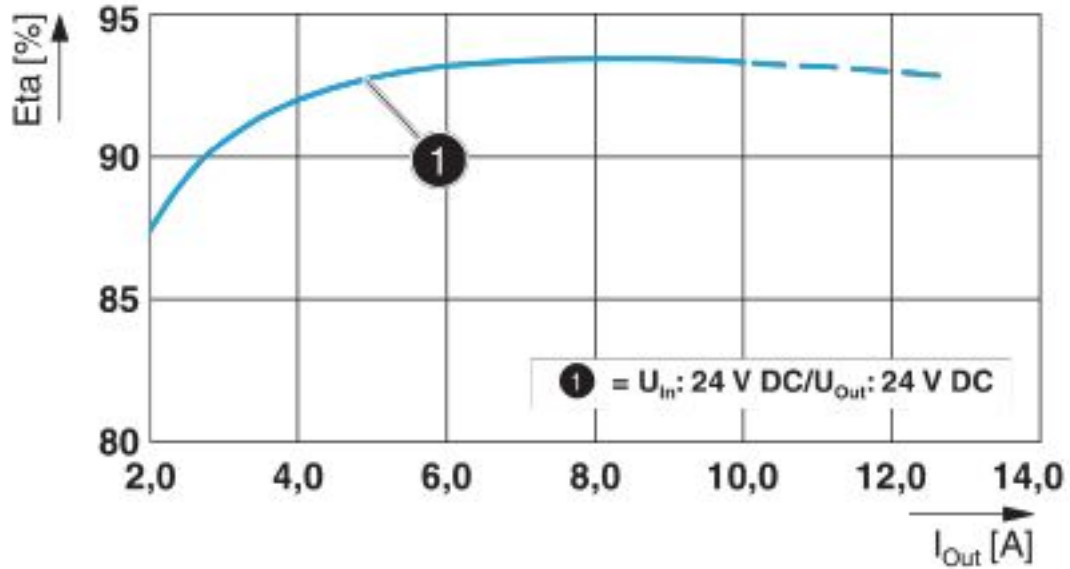

Diagram

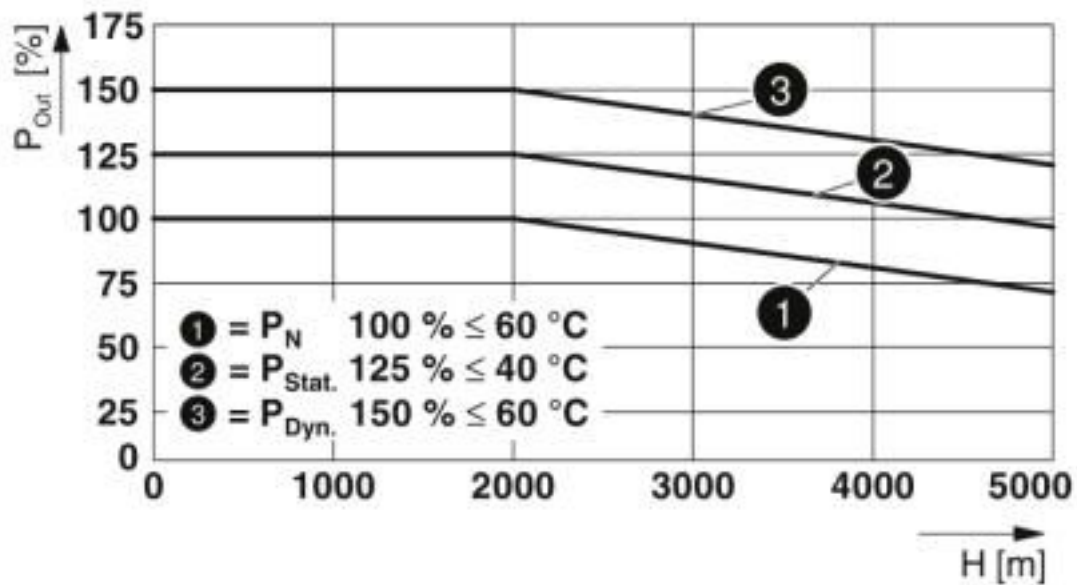

Classifications

eCl@ss

eCl@ss 8.0	27210901
eCl@ss 9.0	27210901

DC/DC converters - QUINT4-PS/24DC/24DC/10/PT - 2910120

Classifications

ETIM

ETIM 5.0	EC002046
ETIM 6.0	EC002046
ETIM 7.0	EC002046

Approvals

Approvals





Approvals

CSA / CSAus / ABS / DNV GL / UL Listed / cUL Listed / Type approved / LR / cCSAus / cULus Listed

Ex Approvals

EAC Ex

Approval details

CSA		http://www.csagroup.org/services-industries/product-listing/	70212082
CSAus		http://www.csagroup.org/services-industries/product-listing/	70212082
ABS		http://www.eagle.org/eagleExternalPortalWEB/	19-HG1860348-PDA
DNV GL		https://approvalfinder.dnvgl.com/	TAA000027S
UL Listed		http://database.ul.com/cgi-bin/XYV/template/LISEXT/1FRAME/index.htm	FILE E 123528
cUL Listed		http://database.ul.com/cgi-bin/XYV/template/LISEXT/1FRAME/index.htm	FILE E 123528

DC/DC converters - QUINT4-PS/24DC/24DC/10/PT - 2910120

Approvals

Type approved		SI-SIQ BG 005/058
---------------	--	-------------------

LR		http://www.lr.org/en	17-20107-02
----	--	---	-------------

cCSAus			
--------	--	--	--

cULus Listed			
--------------	--	--	--

Accessories

Accessories

Assembly adapter

Assembly adapters - UWA 182/52 - 2938235



Universal wall adapter for securely mounting the device in the event of strong vibrations. The device is screwed directly onto the mounting surface. The universal wall adapter is attached on the top/bottom.

Assembly adapters - UWA 130 - 2901664



2-piece universal wall adapter for securely mounting the device in the event of strong vibrations. The profiles that are screwed onto the side of the device are screwed directly onto the mounting surface. The universal wall adapter is attached on the left/right.

DC/DC converters - QUINT4-PS/24DC/24DC/10/PT - 2910120

Accessories

Assembly adapters - QUINT-PS-ADAPTERS7/1 - 2938196



Assembly adapter for QUINT-PS... power supply on S7-300 rail

Device circuit breakers

Electronic device circuit breaker - CBMC E4 24DC/1-4A NO - 2906031



Multi-channel electronic device circuit breaker for protecting four loads at 24 V DC in the event of overload and short circuit. With electronic locking of the set nominal currents. For installation on DIN rails.

Electronic device circuit breaker - CBMC E4 24DC/1-10A NO - 2906032



Multi-channel electronic device circuit breaker for protecting four loads at 24 V DC in the event of overload and short circuit. With electronic locking of the set nominal currents. For installation on DIN rails.

Electronic device circuit breaker - CBMC E4 24DC/1-4A+ IOL - 2910410



Multi-channel electronic circuit breaker with IO-Link interface for protecting four loads at 24 V DC in the event of overload and short circuit. With electronic locking of the set nominal currents. For installation on DIN rails.

Electronic device circuit breaker - CBMC E4 24DC/1-10A IOL - 2910411



Multi-channel electronic circuit breaker with IO-Link interface for protecting four loads at 24 V DC in the event of overload and short circuit. With electronic locking of the set nominal currents. For installation on DIN rails.

DC/DC converters - QUINT4-PS/24DC/24DC/10/PT - 2910120

Accessories

Electronic device circuit breaker - CBM E4 24DC/0.5-10A NO-R - 2905743



Multi-channel, electronic device circuit breaker with active current limitation for protecting four loads at 24 V DC in the event of overload and short circuit. With nominal current assistant and electronic locking of the set nominal currents. For installation on DIN rails.

Electronic device circuit breaker - CBM E8 24DC/0.5-10A NO-R - 2905744



Multi-channel, electronic device circuit breaker with active current limitation for protecting eight loads at 24 V DC in the event of overload and short circuit. With nominal current assistant and electronic locking of the set nominal currents. For installation on DIN rails.

Programming adapter

Programming adapter - TWN4 MIFARE NFC USB ADAPTER - 2909681



Near Field Communication (NFC) programming adapter with USB interface for the wireless configuration of NFC-capable products from PHOENIX CONTACT with software. No separate USB driver is required.
