

Passive module - VIP-3/PT/FLK14/8IM/LED/PLC - 2904281

Please be informed that the data shown in this PDF Document is generated from our Online Catalog. Please find the complete data in the user's documentation. Our General Terms of Use for Downloads are valid (<http://phoenixcontact.com/download>)



VARIOFACE sensor module, for connecting 8 pnp sensors, with LED



Key Commercial Data

Packing unit	1 pc
GTIN	 4 046356 813686
GTIN	4046356813686
Weight per Piece (excluding packing)	149.000 g
Custom tariff number	85366990
Country of origin	United States

Technical data

Dimensions

Width	52 mm
Height	75.8 mm
Depth	63 mm

Ambient conditions

Ambient temperature (operation)	-20 °C ... 50 °C
Ambient temperature (storage/transport)	-20 °C ... 70 °C

General

Nominal voltage U_N	24 V DC
Max. perm. current (per branch)	1 A
Max. permissible current (separate power supply)	3 A

Passive module - VIP-3/PT/FLK14/8IM/LED/PLC - 2904281

Technical data

General

Number of positions	14
Status display	LED
Mounting position	any

Connection data

Connection name	Field level
Connection in acc. with standard	IEC / EN
Connection method	Push-in connection
Stripping length	8 mm
Conductor cross section solid	0.14 mm ² ... 2.5 mm ²
Conductor cross section flexible	0.14 mm ² ... 2.5 mm ²
Conductor cross section AWG	24 ... 12

Connection data 2

Connection name	Controller level
Connection method	IDC/FLK pin strip
Number of connections	1
Number of positions	14
Pitch	2.54 mm

Supported controller

Controller	SIEMENS S7-1500
- suitable I/O card	6ES7 521-1BH00-0AB0
	6ES7 521-1BL00-0AB0
	6ES7 522-1BH00-0AB0
	6ES7 522-1BH01-0AB0
	6ES7 522-1BL00-0AB0
	6ES7 522-1BL01-0AB0
Controller	ABB S800 I/O
- suitable I/O card	DI810
	DI818
	DI830
	DI840
	DO810
	DO840
Controller	ALLEN-BRADLEY ControlLogix
- suitable I/O card	1756-IB32
	1756-OB32
	1756-IB16

Passive module - VIP-3/PT/FLK14/8IM/LED/PLC - 2904281

Technical data

Supported controller

	1756-OB16E
Controller	ALLEN-BRADLEY PLC 5
- suitable I/O card	1771 IBN
	1771 OBN
Controller	ALLEN-BRADLEY SLC 500
- suitable I/O card	1746 OB 32
	1746 IB 32
Controller	GE-FANUC RX3i
- suitable I/O card	IC694MDL754
	IC694MDL660
Controller	HONEYWELL Experion PKS C200
- suitable I/O card	TC-IDD 321
	TC-ODD 321
Controller	MITSUBISHI MELSEC L
- suitable I/O card	LX41C4
	LX42C4
	LY41NT1P
	LY42NT1P
	LY41PT1P
	LY42PT1P
Controller	MITSUBISHI MELSEC Q
- suitable I/O card	QX81
	QY81P
	QX41
	QX41-S1
	QX42
	QX42-S1
	QY41P
	QY42P
	QH42P
	QX82
	QX82-S1
	QY82P
Controller	SIEMENS S7-300 / ET 200 M
- suitable I/O card	CPU 313C-2DP
	CPU 314C-2DP
	CPU 314C-2PtP

Passive module - VIP-3/PT/FLK14/8IM/LED/PLC - 2904281

Technical data

Supported controller

	6ES7 321-1BH02-0AA0
	6ES7 321-1BL00-0AA0
	6ES7 322-1BH01-0AA0
	6ES7 322-1BL00-0AA0
	6ES7 323-1BH01-0AA0
	6ES7 323-1BL00-0AA0
Controller	SIEMENS S7-400
- suitable I/O card	6ES7 421-1BL01-0AA0
	6ES7 422-1BL00-0AA0
	6ES7 422-7BL00-0AB0
Controller	Schneider Electric Modicon TSX QUANTUM
- suitable I/O card	DDI 353
	DDI 853
	DDO 353

Standards and Regulations

Connection in acc. with standard	CSA
Standards/regulations	IEC 60664
	DIN EN 50178
Rated surge voltage	0.6 kV
Pollution degree	2
Overvoltage category	II
Flammability rating according to UL 94	V0

Environmental Product Compliance

China RoHS	Environmentally Friendly Use Period = 50 years
	For details about hazardous substances go to tab "Downloads", Category "Manufacturer's declaration"

Drawings

Passive module - VIP-3/PT/FLK14/8IM/LED/PLC - 2904281

Circuit diagram

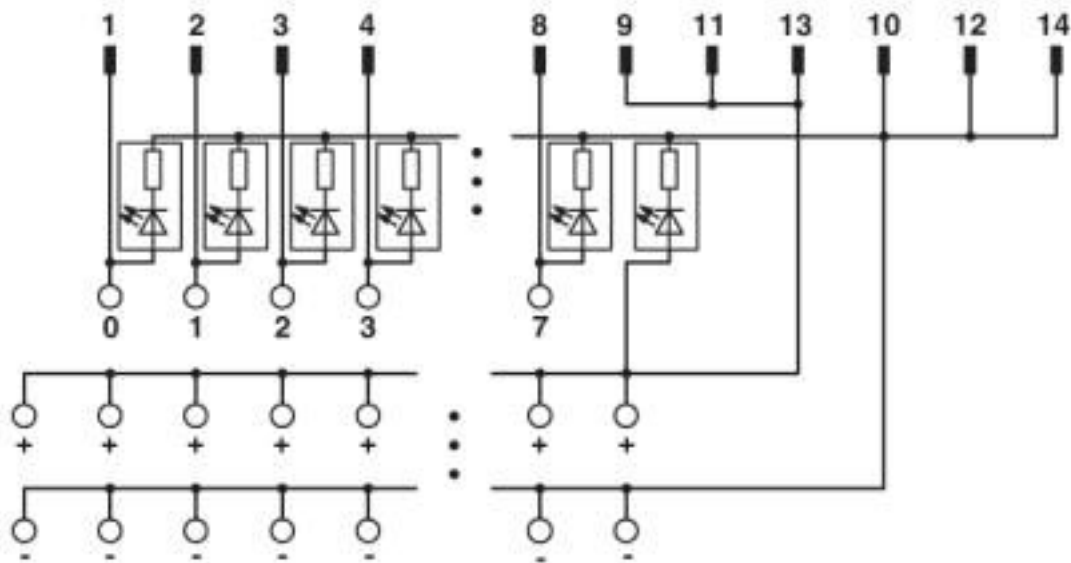

Classifications

eCl@ss

eCl@ss 10.0.1	27141152
eCl@ss 4.0	27250300
eCl@ss 4.1	27250300
eCl@ss 5.0	27250300
eCl@ss 5.1	27250300
eCl@ss 6.0	27242600
eCl@ss 7.0	27141152
eCl@ss 8.0	27141152
eCl@ss 9.0	27141152

ETIM

ETIM 4.0	EC002780
ETIM 5.0	EC002780
ETIM 6.0	EC002780
ETIM 7.0	EC002780

UNSPSC

UNSPSC 6.01	30211824
UNSPSC 7.0901	39121421
UNSPSC 11	39121421

Passive module - VIP-3/PT/FLK14/8IM/LED/PLC - 2904281

Classifications

UNSPSC

UNSPSC 12.01	39121421
UNSPSC 13.2	39121432
UNSPSC 18.0	39121432
UNSPSC 19.0	39121432
UNSPSC 20.0	39121432
UNSPSC 21.0	39121432

Approvals

Approvals

Approvals

CSA / EAC / EAC / UL Recognized / cUL Recognized / CSAus / cULus Recognized / cCSAus

Ex Approvals

Approval details

CSA		http://www.csagroup.org/services-industries/product-listing/	2122203
Nominal voltage UN		24 V	
Nominal current IN		1 A	
mm ² /AWG/kcmil		26-14	

EAC		EAC-Zulassung
-----	---	---------------

EAC		RU C- DE.A*30.B.01742
-----	---	--------------------------

Passive module - VIP-3/PT/FLK14/8IM/LED/PLC - 2904281

Approvals

UL Recognized		http://database.ul.com/cgi-bin/XYV/template/LISEXT/1FRAME/index.htm	FILE E 238705
Nominal voltage UN	24 V		
Nominal current IN	1 A		
mm ² /AWG/kcmil	26-14		

cUL Recognized		http://database.ul.com/cgi-bin/XYV/template/LISEXT/1FRAME/index.htm	FILE E 238705
Nominal voltage UN	24 V		
Nominal current IN	1 A		
mm ² /AWG/kcmil	26-14		

CSAus		http://www.csagroup.org/services-industries/product-listing/	2122203
Nominal voltage UN	24 V		
Nominal current IN	1 A		
mm ² /AWG/kcmil	26-14		

cULus Recognized			
------------------	---	--	--

cCSAus			
--------	---	--	--