

Single relay - REL-PR3-230AC/3X21 - 2903705

Please be informed that the data shown in this PDF Document is generated from our Online Catalog. Please find the complete data in the user's documentation. Our General Terms of Use for Downloads are valid (<http://phoenixcontact.com/download>)



Plug-in high-power relay with power contacts, 3 PDTs, coil voltage: 230 V AC



COMPLETE

Key Commercial Data

Packing unit	1 pc
GTIN	 4 046356 759175
GTIN	4046356759175
Weight per Piece (excluding packing)	80.000 g
Custom tariff number	85364900
Country of origin	Poland

Technical data

Note

Type of note	Notes on operation
Note	The outputs are not suitable for switching different outer conductors.
Type of note	Notes on operation
Note	Do not use to separate SELV / PELV circuits from other circuits, because safe isolation is not guaranteed.

Dimensions

Width	38.6 mm
Height	36.1 mm
Depth	45.5 mm

Ambient conditions

Ambient temperature (operation)	-40 °C ... 55 °C
---------------------------------	------------------

Single relay - REL-PR3-230AC/3X21 - 2903705

Technical data

Ambient conditions

Ambient temperature (storage/transport)	-40 °C ... 85 °C
Maximum altitude	≤ 2000 m
Degree of protection	RT I
	≥ IP54 (Installation location)

Coil side

Nominal input voltage U_N	230 V AC
Mains frequency	50/60 Hz
Typical input current at U_N	12 mA
Typical response time	5 ms ... 25 ms (depending on phase relation)
Typical release time range	5 ms ... 20 ms (depending on phase relation)
Coil resistance	7080 Ω \pm 15 %
Power dissipation for nominal condition	2.76 W

Contact side

Contact type	3 PDTs
Type of switch contact	Single contact
Contact material	AgNi
Maximum switching voltage	440 V AC 250 V DC
Minimum switching voltage	10 V (At 24 mA)
Min. switching current	10 mA (at 24 V)
Maximum inrush current	50 A (20 ms, N/O contacts)
Limiting continuous current	16 A
Interrupting rating (ohmic load) max.	384 W (at 24 V DC) 124 W (at 48 V DC) 108 W (at 60 V DC) 52 W (at 110 V DC) 70 W (at 220 V DC) 4000 VA (for 250 V AC) 4000 VA (at 440 V AC)
3-phase motor load	1500 W (at 400 V, AC3)
Motor load according to UL 508	1/3 HP, 120 V AC (single-phase AC motor) 1/2 HP, 240 V AC (single-phase AC motor) 1/2 HP, 240 V AC (three-phase induction motor)

General

Test voltage relay winding/relay contact	2.5 kV _{rms} (50 Hz, 1 min.)
Test voltage PDT/PDT	2.5 kV _{rms} (50 Hz, 1 min.)

Single relay - REL-PR3-230AC/3X21 - 2903705

Technical data

General

Operating mode	100% operating factor
Mechanical service life	approx. 10^7 cycles
Service life, electrical	see diagram
Mounting position	any

Connection data

Connection method	Plug connection
-------------------	-----------------

Standards and Regulations

Connection in acc. with standard	CSA
Standards/regulations	IEC 60664
	IEC 61810
Rated insulation voltage	250 V AC
Rated surge voltage	4 kV
Insulation	Basic insulation
Pollution degree	3
Overvoltage category	III

Environmental Product Compliance

China RoHS	Environmentally friendly use period: unlimited = EFUP-e
	No hazardous substances above threshold values

Drawings

Single relay - REL-PR3-230AC/3X21 - 2903705

Diagram

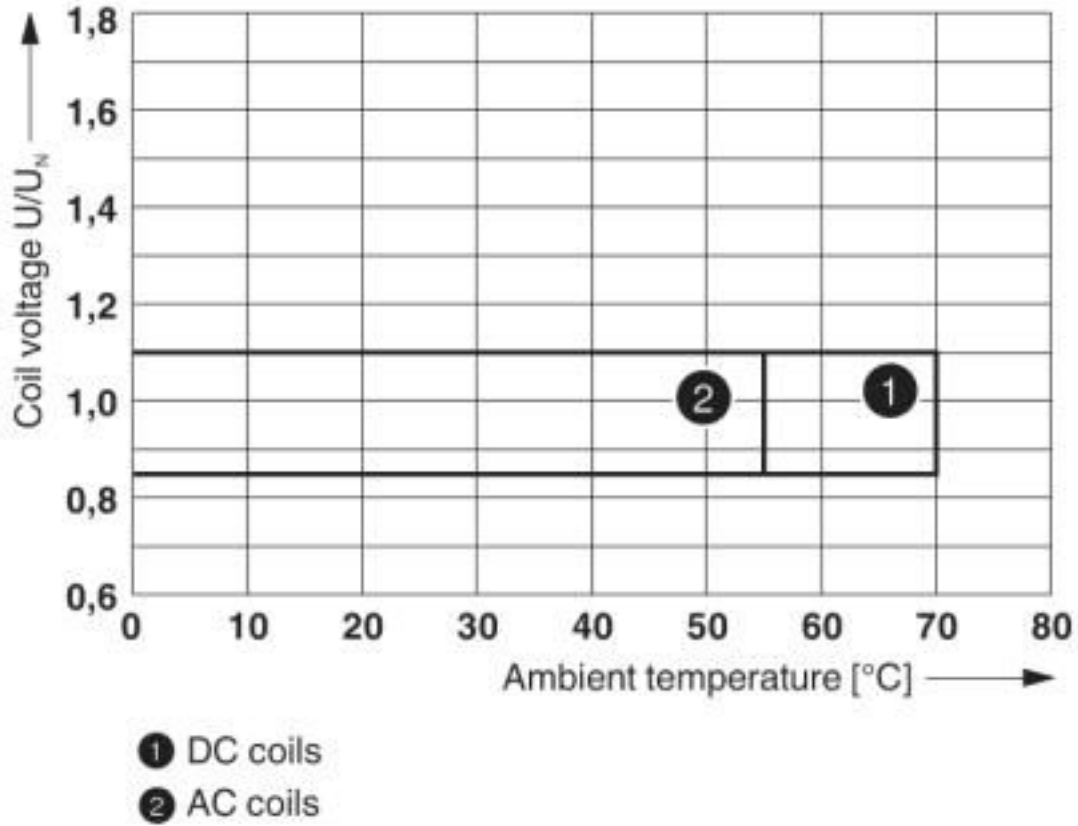

Operating voltage range

Single relay - REL-PR3-230AC/3X21 - 2903705

Diagram

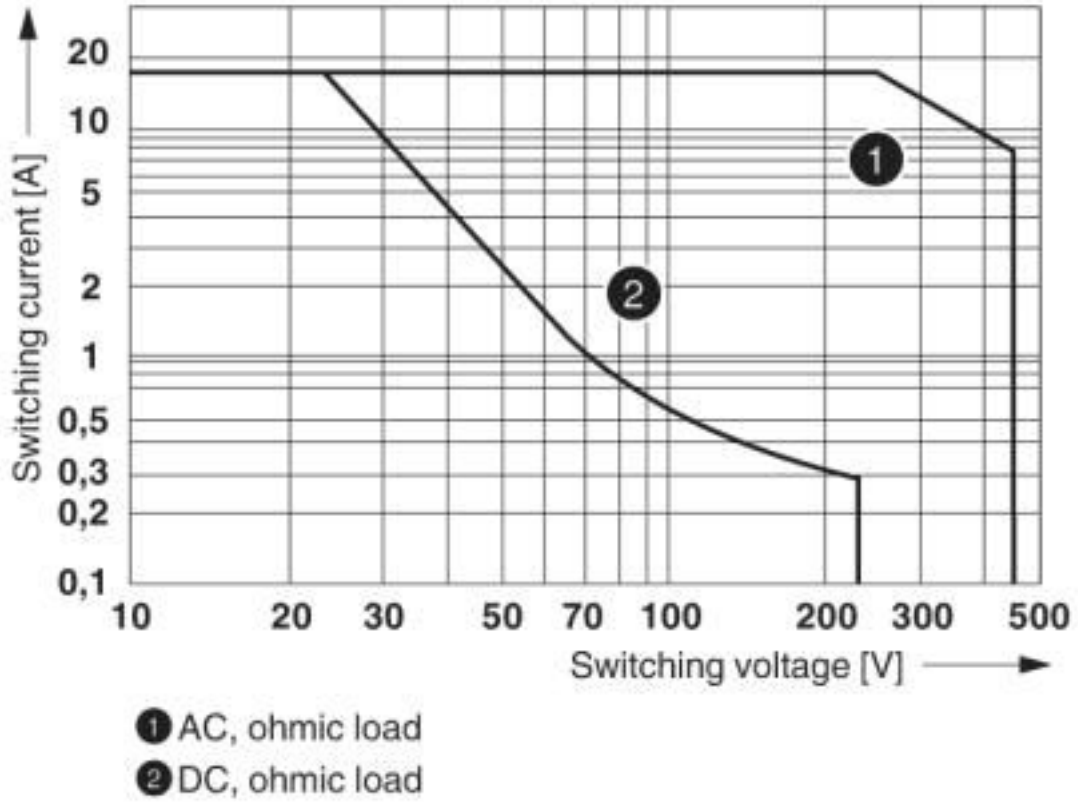

Interrupting rating

Single relay - REL-PR3-230AC/3X21 - 2903705

Diagram

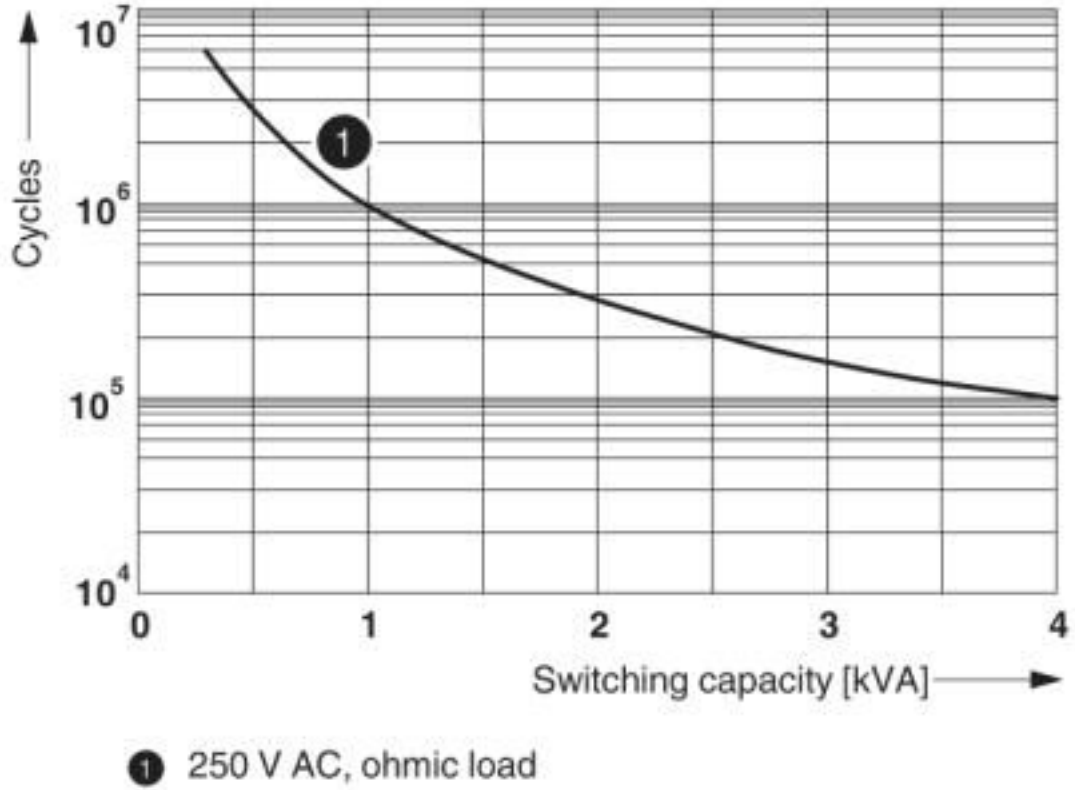

Electrical service life

Single relay - REL-PR3-230AC/3X21 - 2903705

Diagram

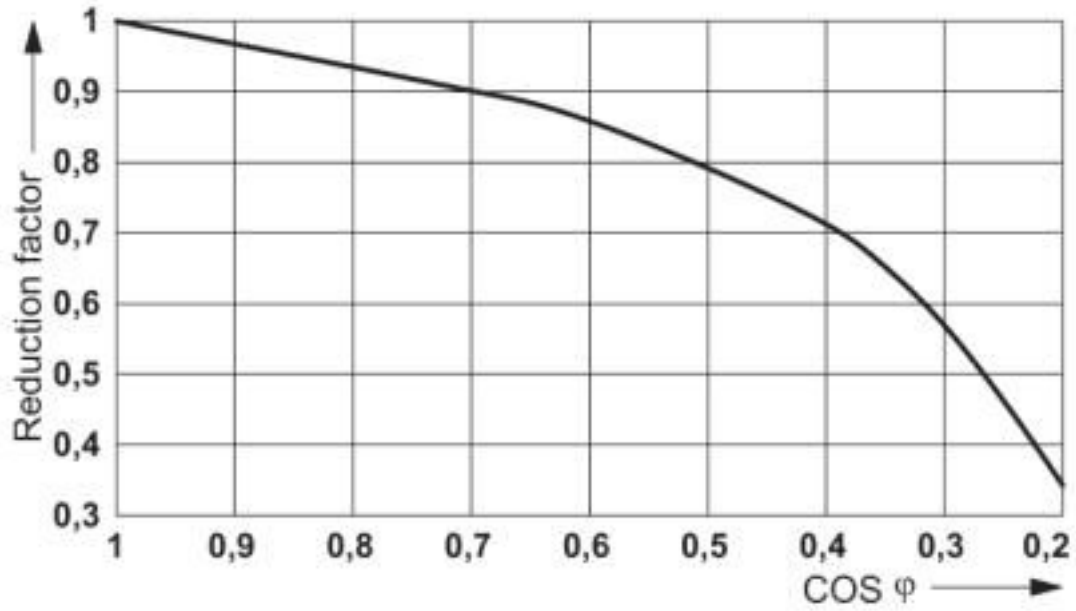

Service life reduction factor

Single relay - REL-PR3-230AC/3X21 - 2903705

Circuit diagram

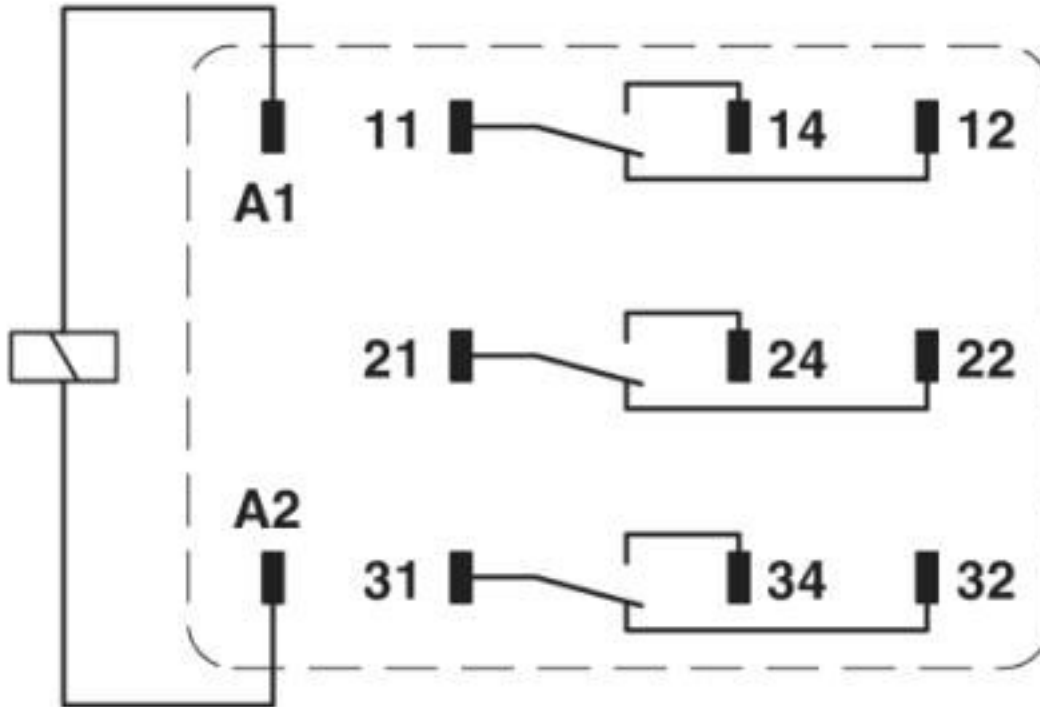

Classifications

eCl@ss

eCl@ss 10.0.1	27371601
eCl@ss 4.0	27371100
eCl@ss 4.1	27371100
eCl@ss 5.0	27371600
eCl@ss 5.1	27371600
eCl@ss 6.0	27371600
eCl@ss 7.0	27371601
eCl@ss 8.0	27371601
eCl@ss 9.0	27371601

ETIM

ETIM 2.0	EC001437
ETIM 3.0	EC001437
ETIM 4.0	EC001437
ETIM 5.0	EC001437
ETIM 6.0	EC001437

Single relay - REL-PR3-230AC/3X21 - 2903705

Classifications

ETIM

ETIM 7.0	EC001437
----------	----------

UNSPSC

UNSPSC 6.01	30211916
UNSPSC 7.0901	39121515
UNSPSC 11	39121515
UNSPSC 12.01	39121515
UNSPSC 13.2	39122334
UNSPSC 18.0	39122334
UNSPSC 19.0	39122334
UNSPSC 20.0	39122334
UNSPSC 21.0	39122334

Approvals

Approvals

Approvals

CSA / UL Recognized / cUL Recognized / EAC / EAC / cULus Recognized

Ex Approvals

Approval details

CSA		http://www.csagroup.org/services-industries/product-listing/	2554095
-----	---	---	---------

UL Recognized		http://database.ul.com/cgi-bin/XYV/template/LISEXT/1FRAME/index.htm	FILE E 172140
---------------	---	---	---------------

cUL Recognized		http://database.ul.com/cgi-bin/XYV/template/LISEXT/1FRAME/index.htm	FILE E 172140
----------------	---	---	---------------

Single relay - REL-PR3-230AC/3X21 - 2903705

Approvals

EAC		TR_TS_D_00573_c
-----	---	-----------------

EAC		RU*C- DE.*08.B.00010
-----	---	-------------------------

cULus Recognized		
------------------	---	--

Accessories

Additional products

Relay base - RIF-4-BPT/3X21 - 2900961



RIF-4... relay base, for high-power relay with 2 or 3 PDTs or 3 N/O contacts, Push-in connection, plug-in option for input/suppressor modules, for mounting on NS 35/7,5

Relay base - RIF-4-BSC/3X21 - 2900960



RIF-4... relay base, for high-power relay with 2 or 3 changeover contacts or 3 N/O contacts, screw connection, plug-in option for input/interference suppression modules, for mounting on NS 35/7,5