

Solid-state relay module - PLC-OPT-110DC/300DC/1 - 2900385

Please be informed that the data shown in this PDF Document is generated from our Online Catalog. Please find the complete data in the user's documentation. Our General Terms of Use for Downloads are valid (<http://phoenixcontact.com/download>)



PLC-INTERFACE, integrated solid-state relay, with push-in connection, for mounting on NS 35/7,5 DIN rails, input: 110 V DC, output: 12 - 300 V DC/1 A

Your advantages

- ✓ Wear-free switching with no contact bounce
- ✓ Resistant to vibrations and shocks
- ✓ Protective circuit in input and output
- ✓ Status indicator
- ✓ DC voltage outputs up to 300 V DC/1 A
- ✓ Option of bridging adjacent modules



Key Commercial Data

Packing unit	1 pc
GTIN	 4 046356 506892
GTIN	4046356506892
Weight per Piece (excluding packing)	99.990 g
Custom tariff number	85364900
Country of origin	Germany

Technical data

Note

Utilization restriction	EMC: class A product, see manufacturer's declaration in the download area
-------------------------	---

Dimensions

Width	6.2 mm
-------	--------

Solid-state relay module - PLC-OPT-110DC/300DC/1 - 2900385

Technical data

Dimensions

Height	80 mm
Depth	86 mm

Ambient conditions

Ambient temperature (operation)	-25 °C ... 60 °C
Ambient temperature (storage/transport)	-40 °C ... 85 °C

Input data

Nominal input voltage U_N	110 V DC
Input voltage range in reference to U_N	0.8 ... 1.2
Input voltage range	88 V DC ... 132 V DC
Switching threshold "0" signal in reference to U_N	≤ 0.4
Switching threshold "1" signal in reference to U_N	≥ 0.8
Typical input current at U_N	5 mA
Typical response time	0.4 ms
Typical turn-off time	0.7 ms
Operating voltage display	Yellow LED
Type of protection	Reverse polarity protection
	Surge protection
Protective circuit/component	Polarity protection diode
	Varistor
Transmission frequency	50 Hz
Power dissipation for nominal condition	0.55 W

Output data

Designation	Output data
Output voltage range	12 V DC ... 300 V DC (Partition plate PLC-ATP must be installed for voltages larger than 250 V (L1, L2, L3) between identical terminal points in adjacent modules. Potential bridging is then carried out with FBST 8-PLC... or ...FBST 500...)
Limiting continuous current	1 A (see derating curve)
Voltage drop at max. limiting continuous current	< 500 mV
Type of protection	Reverse polarity protection
	Surge protection
Protective circuit/component	Polarity protection diode
	Varistor

General

Mounting position	any
Assembly instructions	In rows with zero spacing

Solid-state relay module - PLC-OPT-110DC/300DC/1 - 2900385

Technical data

General

Operating mode	100% operating factor
Flammability rating according to UL 94	V0 (Housing)

Connection data

Connection name	Input side
Connection method	Push-in connection
Stripping length	8 mm
Conductor cross section solid	0.14 mm ² ... 2.5 mm ²
Conductor cross section flexible	0.14 mm ² ... 2.5 mm ²
Conductor cross section AWG	26 ... 14

Connection data 2

Connection name	Output side
Connection method	Push-in connection
Stripping length	8 mm
Conductor cross section solid	0.14 mm ² ... 2.5 mm ²
Conductor cross section flexible	0.14 mm ² ... 2.5 mm ²
Conductor cross section AWG	26 ... 14

Standards and Regulations

Connection in acc. with standard	CUL
Designation	Standards/regulations
Standards/regulations	IEC 60664
	EN 50178
Rated insulation voltage	300 V
Rated surge voltage	2.5 kV
Insulation	Basic insulation
Pollution degree	2
Overvoltage category	III

Environmental Product Compliance

REACH SVHC	Lead 7439-92-1
China RoHS	Environmentally Friendly Use Period = 50 years
	For details about hazardous substances go to tab "Downloads", Category "Manufacturer's declaration"

Drawings

Solid-state relay module - PLC-OPT-110DC/300DC/1 - 2900385

Diagram

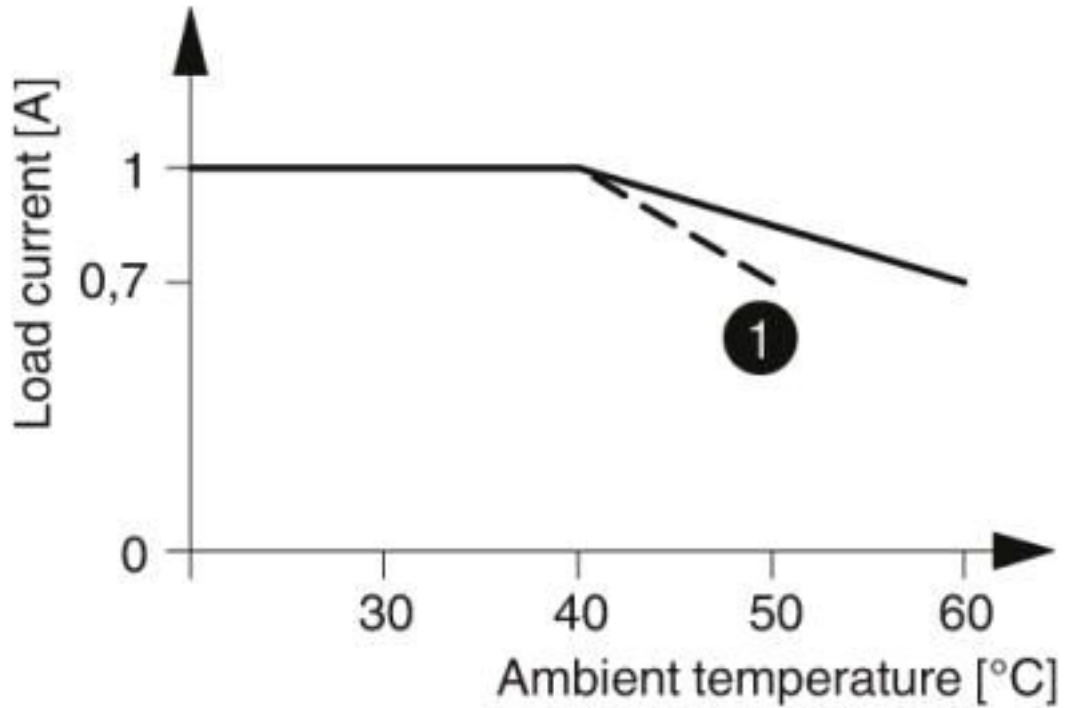

❶ For input voltages 220 V DC and 230 V AC

The figure shows the derating curve for PLC-...300DC/1

Circuit diagram

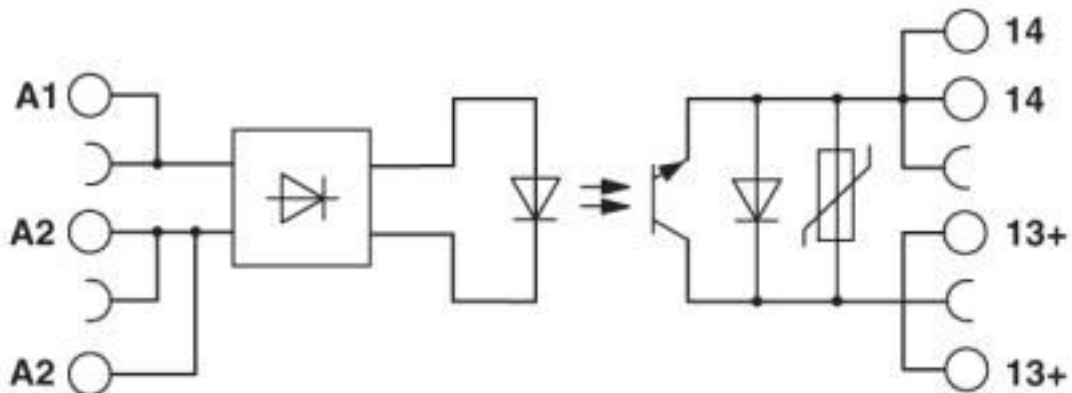

Solid-state relay module - PLC-OPT-110DC/300DC/1 - 2900385

Classifications

eCl@ss

eCl@ss 10.0.1	27371604
eCl@ss 4.0	27371100
eCl@ss 4.1	27371100
eCl@ss 5.0	27371000
eCl@ss 5.1	27371000
eCl@ss 6.0	27371600
eCl@ss 7.0	27371604
eCl@ss 8.0	27371604
eCl@ss 9.0	27371604

ETIM

ETIM 2.0	EC001504
ETIM 3.0	EC001504
ETIM 4.0	EC001504
ETIM 5.0	EC001504
ETIM 6.0	EC001504
ETIM 7.0	EC001504

UNSPSC

UNSPSC 6.01	30211916
UNSPSC 7.0901	39121542
UNSPSC 11	39121542
UNSPSC 12.01	39121542
UNSPSC 13.2	39122326
UNSPSC 18.0	39122326
UNSPSC 19.0	39122326
UNSPSC 20.0	39122326
UNSPSC 21.0	39122326

Approvals

Approvals

Approvals

DNV GL / UL Listed / UL Recognized / cUL Recognized / cUL Listed / EAC / EAC / cULus Recognized / cULus Listed

Ex Approvals

Solid-state relay module - PLC-OPT-110DC/300DC/1 - 2900385

Approvals

Approval details

DNV GL		https://approvalfinder.dnvgl.com/	TAE0000196-03
UL Listed		http://database.ul.com/cgi-bin/XYV/template/LISEXT/1FRAME/index.htm	FILE E 172140
UL Recognized		http://database.ul.com/cgi-bin/XYV/template/LISEXT/1FRAME/index.htm	FILE E 238705
cUL Recognized		http://database.ul.com/cgi-bin/XYV/template/LISEXT/1FRAME/index.htm	FILE E 238705
cUL Listed		http://database.ul.com/cgi-bin/XYV/template/LISEXT/1FRAME/index.htm	FILE E 172140
EAC			TR_TS_D_00573_c
EAC			RU*C- DE.*08.B.00010
cULus Recognized			
cULus Listed			

Solid-state relay module - PLC-OPT-110DC/300DC/1 - 2900385

Accessories

Accessories

Bridge

Continuous plug-in bridge - FBST 500-PLC RD - 2966786



Continuous plug-in bridge, length: 500 mm, color: red

Continuous plug-in bridge - FBST 500-PLC BU - 2966692



Continuous plug-in bridge, length: 500 mm, color: blue

Continuous plug-in bridge - FBST 500-PLC GY - 2966838



Continuous plug-in bridge, length: 500 mm, color: gray

Single plug-in bridge - FBST 6-PLC RD - 2966236



Single plug-in bridge, length: 6 mm, number of positions: 2, color: red

Single plug-in bridge - FBST 6-PLC BU - 2966812



Single plug-in bridge, length: 6 mm, number of positions: 2, color: blue

Solid-state relay module - PLC-OPT-110DC/300DC/1 - 2900385

Accessories

Single plug-in bridge - FBST 6-PLC GY - 2966825



Single plug-in bridge, length: 6 mm, number of positions: 2, color: gray

Single plug-in bridge - FBST 8-PLC GY - 2967688



Single plug-in bridge, length: 8 mm, number of positions: 2, color: gray

Single plug-in bridge - FBST 14-PLC BK - 2967691



Single plug-in bridge, length: 14 mm, number of positions: 2, color: black

DIN rail

DIN rail perforated - NS 35/ 7,5 PERF 2000MM - 0801733



DIN rail perforated, Standard profile, width: 35 mm, height: 7.5 mm, acc. to EN 60715, material: Steel, galvanized, passivated with a thick layer, length: 2000 mm, color: silver

DIN rail, unperforated - NS 35/ 7,5 UNPERF 2000MM - 0801681



DIN rail, unperforated, Standard profile, width: 35 mm, height: 7.5 mm, acc. to EN 60715, material: Steel, galvanized, passivated with a thick layer, length: 2000 mm, color: silver

Solid-state relay module - PLC-OPT-110DC/300DC/1 - 2900385

Accessories

DIN rail perforated - NS 35/ 7,5 WH PERF 2000MM - 1204119



DIN rail perforated, Standard profile, width: 35 mm, height: 7.5 mm, acc. to EN 60715, material: Steel, Galvanized, white passivated, length: 2000 mm, color: silver

DIN rail, unperforated - NS 35/ 7,5 WH UNPERF 2000MM - 1204122



DIN rail, unperforated, Standard profile, width: 35 mm, height: 7.5 mm, acc. to EN 60715, material: Steel, Galvanized, white passivated, length: 2000 mm, color: silver

DIN rail, unperforated - NS 35/ 7,5 AL UNPERF 2000MM - 0801704



DIN rail, unperforated, Standard profile, width: 35 mm, height: 7.5 mm, acc. to EN 60715, material: Aluminum, uncoated, length: 2000 mm, color: silver

DIN rail perforated - NS 35/ 7,5 ZN PERF 2000MM - 1206421



DIN rail perforated, Standard profile, width: 35 mm, height: 7.5 mm, acc. to EN 60715, material: Steel, galvanized, length: 2000 mm, color: silver

DIN rail, unperforated - NS 35/ 7,5 ZN UNPERF 2000MM - 1206434



DIN rail, unperforated, Standard profile, width: 35 mm, height: 7.5 mm, acc. to EN 60715, material: Steel, galvanized, length: 2000 mm, color: silver

Solid-state relay module - PLC-OPT-110DC/300DC/1 - 2900385

Accessories

DIN rail, unperforated - NS 35/ 7,5 CU UNPERF 2000MM - 0801762



DIN rail, unperforated, Standard profile, width: 35 mm, height: 7.5 mm, acc. to EN 60715, material: Copper, uncoated, length: 2000 mm, color: copper-colored

End cap - NS 35/ 7,5 CAP - 1206560



DIN rail end piece, for DIN rail NS 35/7.5

DIN rail perforated - NS 35/15 PERF 2000MM - 1201730



DIN rail perforated, Standard profile, width: 35 mm, height: 15 mm, similar to EN 60715, material: Steel, galvanized, passivated with a thick layer, length: 2000 mm, color: silver

DIN rail, unperforated - NS 35/15 UNPERF 2000MM - 1201714



DIN rail, unperforated, Standard profile, width: 35 mm, height: 15 mm, similar to EN 60715, material: Steel, galvanized, passivated with a thick layer, length: 2000 mm, color: silver

DIN rail perforated - NS 35/15 WH PERF 2000MM - 0806602



DIN rail perforated, Standard profile, width: 35 mm, height: 15 mm, similar to EN 60715, material: Steel, Galvanized, white passivated, length: 2000 mm, color: silver

Solid-state relay module - PLC-OPT-110DC/300DC/1 - 2900385

Accessories

DIN rail, unperforated - NS 35/15 WH UNPERF 2000MM - 1204135



DIN rail, unperforated, Standard profile, width: 35 mm, height: 15 mm, similar to EN 60715, material: Steel, Galvanized, white passivated, length: 2000 mm, color: silver

DIN rail, unperforated - NS 35/15 AL UNPERF 2000MM - 1201756



DIN rail, unperforated, Standard profile, width: 35 mm, height: 15 mm, similar to EN 60715, material: Aluminum, uncoated, length: 2000 mm, color: silver

DIN rail perforated - NS 35/15 ZN PERF 2000MM - 1206599



DIN rail perforated, Standard profile, width: 35 mm, height: 15 mm, similar to EN 60715, material: Steel, galvanized, length: 2000 mm, color: silver

DIN rail, unperforated - NS 35/15 ZN UNPERF 2000MM - 1206586



DIN rail, unperforated, Standard profile, width: 35 mm, height: 15 mm, similar to EN 60715, material: Steel, galvanized, length: 2000 mm, color: silver

DIN rail, unperforated - NS 35/15 CU UNPERF 2000MM - 1201895



DIN rail, unperforated, Standard profile, width: 35 mm, height: 15 mm, similar to EN 60715, material: Copper, uncoated, length: 2000 mm, color: copper-colored

Solid-state relay module - PLC-OPT-110DC/300DC/1 - 2900385

Accessories

End cap - NS 35/15 CAP - 1206573



DIN rail end piece, for DIN rail NS 35/15

DIN rail, unperforated - NS 35/15-2,3 UNPERF 2000MM - 1201798



DIN rail, unperforated, Standard profile 2.3 mm, width: 35 mm, height: 15 mm, acc. to EN 60715, material: Steel, galvanized, passivated with a thick layer, length: 2000 mm, color: silver

Partition plate

Separating plate - PLC-ATP BK - 2966841



Separating plate, 2 mm thick, required at the start and end of a PLC terminal strip. Furthermore, it is used for: visual separation of groups, safe isolation of different voltages of neighboring PLC relays in acc. with DIN VDE 0106-101, isolation

Power module

Power terminal block - PLC-ESK GY - 2966508



Power terminal block, for the input of up to four potentials, for mounting on NS 35/7.5

Screwdriver tools

Solid-state relay module - PLC-OPT-110DC/300DC/1 - 2900385

Accessories

Screwdriver - SZF 1-0,6X3,5 - 1204517



Actuation tool, for ST terminal blocks, also suitable for use as a bladed screwdriver, size: 0.6 x 3.5 x 100 mm, 2-component grip, with non-slip grip

Phoenix Contact 2020 © - all rights reserved
<http://www.phoenixcontact.com>