

Front plate - UM-ALU 4-72 FRONT 200 AP - 2202091

Please be informed that the data shown in this PDF Document is generated from our Online Catalog. Please find the complete data in the user's documentation. Our General Terms of Use for Downloads are valid (<http://phoenixcontact.com/download>)

Press-drawn section housings, Basic profile front plate, width: 71.8 mm, length: 200 mm, color: aluminum color, recommended for UM-ALU 4-..COVER PA.. lateral elements



Your advantages

- Item is from the UM-ALU product range
- Aluminum press-drawn section
- Available in lengths from 42.5 mm ... 990 mm, can be cut to any length
- Available in overall widths of 75 mm and 105 mm
- Variety of connection technologies
- Can be mounted on the DIN rail
- EMC protection

Key Commercial Data

Packing unit	1
GTIN	 4 046356 987592
GTIN	4046356987592
Custom tariff number	76061191

Technical data

Product properties

Brief article description	Front plate
Type	UM-ALU 4-72 FRONT 200 AP
Order No.	2202091
Housing type	Press-drawn section housings
Type	Basic profile front plate

Front plate - UM-ALU 4-72 FRONT 200 AP - 2202091

Technical data

Product properties

Max. IP code to attain	IP40
------------------------	------

Dimensions

Width [w]	71.8 mm
Length [l]	200 mm
Depth [d]	2 mm

Material specifications

Material	Aluminum
Color	aluminum color
Surface characteristics	anodized

Ambient conditions

Ambient temperature (storage/transport)	-40 °C ... 55 °C
Ambient temperature (assembly)	-5 °C ... 100 °C
Ambient temperature (operation)	-40 °C ... 105 °C (depending on power dissipation)

PCB specifications

Mounting position	parallel to the DIN rail
-------------------	--------------------------

Packaging specifications

Type of packaging	packed in cardboard
Pieces per package	1
Denomination packing units	Pcs.
Outer packaging type	Carton

Environmental Product Compliance

China RoHS	Environmentally friendly use period: unlimited = EFUP-e
	No hazardous substances above threshold values

Drawings

Front plate - UM-ALU 4-72 FRONT 200 AP - 2202091

Schematic diagram

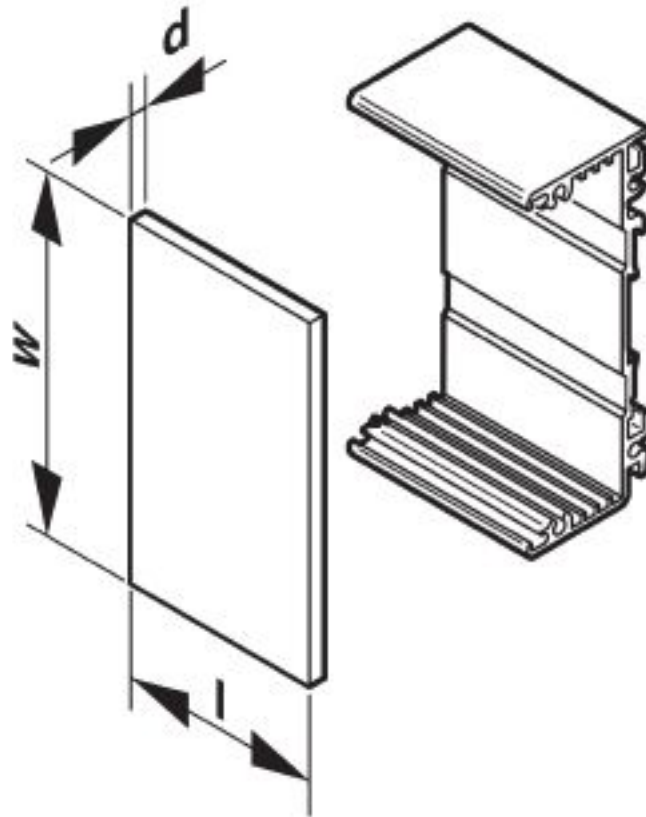

Classifications

eCl@ss

eCl@ss 10.0.1	27182701
eCl@ss 5.0	27180500
eCl@ss 5.1	27180500
eCl@ss 6.0	27182000
eCl@ss 7.0	27182701
eCl@ss 8.0	27182701
eCl@ss 9.0	27182701

Front plate - UM-ALU 4-72 FRONT 200 AP - 2202091

Classifications

ETIM

ETIM 5.0	EC002779
ETIM 6.0	EC002779
ETIM 7.0	EC002779

UNSPSC

UNSPSC 13.2	31261501
UNSPSC 18.0	31261501
UNSPSC 19.0	31261501
UNSPSC 20.0	31261501
UNSPSC 21.0	31261501

Accessories

Necessary add-on products

Profile - UM-ALU 4-72 PROFILE 200 - 2200922



Press-drawn section housings, Basic profile, profile width (internal): 72 mm, length: 200 mm, color: aluminum color