

Cable gland - VC-M-KV-PG16 1X3/2X8 - 1885499

Please be informed that the data shown in this PDF Document is generated from our Online Catalog. Please find the complete data in the user's documentation. Our General Terms of Use for Downloads are valid (<http://phoenixcontact.com/download>)



Multiple screw connection Pg16, made of metal, consisting of rubber seal with several holes (1 x 3 mm/2 x 8 mm) and a pressure screw, for cable screw connection support VC-M-KV-PG16.....



Key Commercial Data

Packing unit	1 pc
Minimum order quantity	5 pc
GTIN	 4 017918 176594
GTIN	4017918176594
Weight per Piece (excluding packing)	17.020 g
Custom tariff number	74153300
Country of origin	Poland

Technical data

Dimensions

Length	24.5 mm
Wrench size, union nut	24 mm
External cable diameter	2.5 mm ... 3 mm (Cable 1)

Ambient conditions

Degree of protection (IP)	IP65
Ambient temperature (operation)	-40 °C ... 125 °C

General

No. of conductors	3
Material, pressure screw	Nickel-plated brass

Cable gland - VC-M-KV-PG16 1X3/2X8 - 1885499

Technical data

General

Seal material	TPE
Cable seal material	TPE
Sealing material	TPE
Shielded	no
Thread type on seal side	Pg16
Tightening torque, union nut	7.50 Nm

Standards and Regulations

Safety note	<p>WARNING: The connectors may not be plugged in or disconnected under load. Ignoring the warning or improper use may damage persons and/or property.</p>
	<ul style="list-style-type: none"> • WARNING: Commission properly functioning products only. The products must be regularly inspected for damage. Decommission defective products immediately. Replace damaged products. Repairs are not possible.
	<ul style="list-style-type: none"> • WARNING: Only electrically qualified personnel may install and operate the product. They must observe the following safety notes. The qualified personnel must be familiar with the basics of electrical engineering. They must be able to recognize and prevent danger. The relevant symbol on the packaging indicates that only personnel familiar with electrical engineering are allowed to install and operate the product.
	<ul style="list-style-type: none"> • The products are suitable for applications in plant, controller, and electrical device engineering.
	<ul style="list-style-type: none"> • When operating the connectors in outdoor applications, they must be separately protected against environmental influences.
	<ul style="list-style-type: none"> • Assembled products may not be manipulated or improperly opened.
	<ul style="list-style-type: none"> • Only use mating connectors that are specified in the technical data of the standards listed (e.g. the ones listed in the product accessories online at phoenixcontact.com/products).
	<ul style="list-style-type: none"> • When using the product in direct connection with third-party manufacturers, the user is responsible.
	<ul style="list-style-type: none"> • For operating voltages > 50 V AC, conductive connector housings must be grounded
	<ul style="list-style-type: none"> • Ensure that the protective or functional ground has been properly connected.
	<ul style="list-style-type: none"> • VDE 0100/1.97 § 411.1.3.2 and DIN EN 60 204/11.98 § 14.1.3 are applicable when combining several circuits in a cable and/or connector
	<ul style="list-style-type: none"> • Observe the corresponding technical data. You will find information: <ul style="list-style-type: none"> o On the product o On the packing label o In the supplied documentation o Online at phoenixcontact.com/products under the product
	<ul style="list-style-type: none"> • Only use tools recommended by Phoenix Contact
	<ul style="list-style-type: none"> • The installation notes/Design In documents online on the download page at phoenixcontact.com/products must be observed for this product.

Cable gland - VC-M-KV-PG16 1X3/2X8 - 1885499

Technical data

Standards and Regulations

	<ul style="list-style-type: none">• Use a protective cap to protect connectors that are not in use. The suitable accessories are available online in the accessory section of the product at phoenixcontact.com/products
	<ul style="list-style-type: none">• Operate the connector only when it is fully plugged in.
	<ul style="list-style-type: none">• Ensure that when laying the cable, the tensile load on the connectors does not exceed the upper limit specified in the standards.
	<ul style="list-style-type: none">• Observe the minimum bending radius of the cable. Lay the cable without twisting it.

Environmental Product Compliance

REACH SVHC	Lead 7439-92-1
China RoHS	Environmentally Friendly Use Period = 50 years
	For details about hazardous substances go to tab "Downloads", Category "Manufacturer's declaration"

Drawings

Cable gland - VC-M-KV-PG16 1X3/2X8 - 1885499

Dimensional drawing

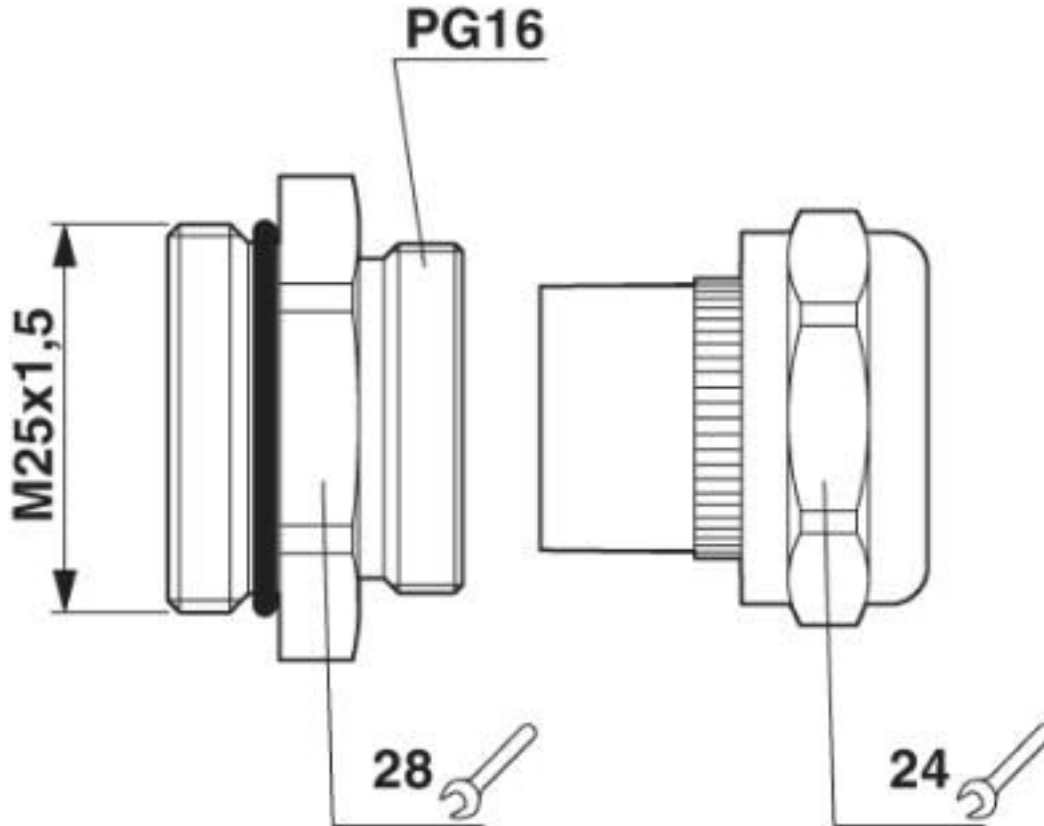

Classifications

eCl@ss

eCl@ss 10.0.1	27144432
eCl@ss 4.0	27141200
eCl@ss 4.1	27141200
eCl@ss 5.0	27149100
eCl@ss 5.1	27149100
eCl@ss 6.0	27149100
eCl@ss 7.0	27149109
eCl@ss 8.0	27149109
eCl@ss 9.0	27144432

ETIM

ETIM 2.0	EC000441
ETIM 3.0	EC000441

Cable gland - VC-M-KV-PG16 1X3/2X8 - 1885499

Classifications

ETIM

ETIM 4.0	EC000441
ETIM 5.0	EC000441
ETIM 6.0	EC000441
ETIM 7.0	EC000441

UNSPSC

UNSPSC 6.01	31261502
UNSPSC 7.0901	31261502
UNSPSC 11	31261502
UNSPSC 12.01	31261502
UNSPSC 13.2	39121311
UNSPSC 18.0	39121311
UNSPSC 19.0	39121311
UNSPSC 20.0	39121311
UNSPSC 21.0	39121311

Approvals

Approvals

Approvals

EAC

Ex Approvals

Approval details

EAC		B.01687
-----	---	---------

Accessories

Accessories

Cable gland - VC-M-KV-PG16 1X3/2X8 - 1885499

Accessories

Half screw connection - VC-M-KV-PG21- 0 - 1854983



Half screw connection made of metal with rubber seal without hole for sealing or for individual holes