

## Protective covers - VC-SD2 - 1853683

Please be informed that the data shown in this PDF Document is generated from our Online Catalog. Please find the complete data in the user's documentation. Our General Terms of Use for Downloads are valid (<http://phoenixcontact.com/download>)



Protective cover, Protective covers, type: VC2, housing material: PA 6, color: gray

### Your advantages

- Easy mounting
- Contact inserts are protected when not plugged in

### Key Commercial Data

Packing unit	1 pc
Minimum order quantity	5 pc
GTIN	 4 017918 145903
GTIN	4017918145903
Weight per Piece (excluding packing)	12.220 g
Custom tariff number	39269097
Country of origin	Poland

### Technical data

#### Dimensions

Width	71.5 mm
Height	31 mm

#### Ambient conditions

Ambient temperature (operation)	-40 °C ... 80 °C
---------------------------------	------------------

#### General

Size	VC2
------	-----

## Protective covers - VC-SD2 - 1853683

### Technical data

#### General

Type	For panel mounting frames
Material	PA
Flammability rating according to UL 94	V0
Seal present	no
Mounting type	Clip locking

#### Standards and Regulations

Flammability rating according to UL 94	V0
Safety note	WARNING: The connectors may not be plugged in or disconnected under load. Ignoring the warning or improper use may damage persons and/or property.
	<ul style="list-style-type: none"> <li>• WARNING: Commission properly functioning products only. The products must be regularly inspected for damage. Decommission defective products immediately. Replace damaged products. Repairs are not possible.</li> </ul>
	<ul style="list-style-type: none"> <li>• WARNING: Only electrically qualified personnel may install and operate the product. They must observe the following safety notes. The qualified personnel must be familiar with the basics of electrical engineering. They must be able to recognize and prevent danger. The relevant symbol on the packaging indicates that only personnel familiar with electrical engineering are allowed to install and operate the product.</li> </ul>
	<ul style="list-style-type: none"> <li>• The products are suitable for applications in plant, controller, and electrical device engineering.</li> </ul>
	<ul style="list-style-type: none"> <li>• When operating the connectors in outdoor applications, they must be separately protected against environmental influences.</li> </ul>
	<ul style="list-style-type: none"> <li>• Assembled products may not be manipulated or improperly opened.</li> </ul>
	<ul style="list-style-type: none"> <li>• Only use mating connectors that are specified in the technical data of the standards listed (e.g. the ones listed in the product accessories online at <a href="https://www.phoenixcontact.com/products">phoenixcontact.com/products</a>).</li> </ul>
	<ul style="list-style-type: none"> <li>• When using the product in direct connection with third-party manufacturers, the user is responsible.</li> </ul>
	<ul style="list-style-type: none"> <li>• For operating voltages &gt; 50 V AC, conductive connector housings must be grounded</li> </ul>
	<ul style="list-style-type: none"> <li>• Ensure that the protective or functional ground has been properly connected.</li> </ul>
	<ul style="list-style-type: none"> <li>• VDE 0100/1.97 § 411.1.3.2 and DIN EN 60 204/11.98 § 14.1.3 are applicable when combining several circuits in a cable and/or connector</li> </ul>
	<ul style="list-style-type: none"> <li>• Observe the corresponding technical data. You will find information:                             <ul style="list-style-type: none"> <li>o On the product</li> <li>o On the packing label</li> <li>o In the supplied documentation</li> <li>o Online at <a href="https://www.phoenixcontact.com/products">phoenixcontact.com/products</a> under the product</li> </ul> </li> </ul>
	<ul style="list-style-type: none"> <li>• Only use tools recommended by Phoenix Contact</li> </ul>
	<ul style="list-style-type: none"> <li>• The installation notes/Design In documents online on the download page at <a href="https://www.phoenixcontact.com/products">phoenixcontact.com/products</a> must be observed for this product.</li> </ul>

## Protective covers - VC-SD2 - 1853683

### Technical data

#### Standards and Regulations

	<ul style="list-style-type: none"> <li>• Use a protective cap to protect connectors that are not in use. The suitable accessories are available online in the accessory section of the product at phoenixcontact.com/products</li> </ul>
	<ul style="list-style-type: none"> <li>• Operate the connector only when it is fully plugged in.</li> </ul>
	<ul style="list-style-type: none"> <li>• Ensure that when laying the cable, the tensile load on the connectors does not exceed the upper limit specified in the standards.</li> </ul>
	<ul style="list-style-type: none"> <li>• Observe the minimum bending radius of the cable. Lay the cable without twisting it.</li> </ul>

#### Environmental Product Compliance

China RoHS	Environmentally friendly use period: unlimited = EFUP-e
	No hazardous substances above threshold values

### Drawings

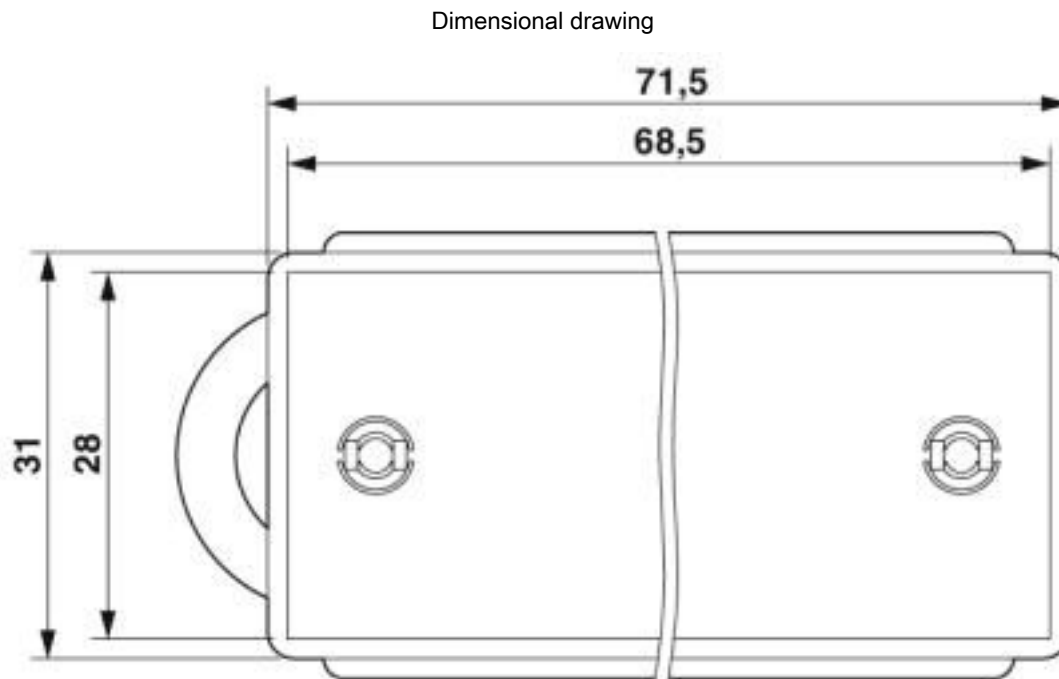

### Classifications

eCl@ss

eCl@ss 10.0.1	27440208
eCl@ss 4.0	27141200
eCl@ss 4.1	27141200

## Protective covers - VC-SD2 - 1853683

### Classifications

#### eCl@ss

eCl@ss 5.0	27142100
eCl@ss 5.1	27142100
eCl@ss 6.0	27261200
eCl@ss 7.0	27440208
eCl@ss 8.0	27440208
eCl@ss 9.0	27440208

#### ETIM

ETIM 2.0	EC000241
ETIM 3.0	EC002040
ETIM 4.0	EC002040
ETIM 5.0	EC002314
ETIM 6.0	EC002314
ETIM 7.0	EC002314

#### UNSPSC

UNSPSC 6.01	30212113
UNSPSC 7.0901	39121712
UNSPSC 11	39121712
UNSPSC 12.01	39121712
UNSPSC 13.2	39121421
UNSPSC 18.0	39121421
UNSPSC 19.0	39121421
UNSPSC 20.0	39121421
UNSPSC 21.0	39121421