

Accessories - IC-DFR 5 - 1852053

Please be informed that the data shown in this PDF Document is generated from our Online Catalog. Please find the complete data in the user's documentation. Our General Terms of Use for Downloads are valid (<http://phoenixcontact.com/download>)



Panel mounting frame, nominal cross section: 2.5 mm², number of positions: 5, pitch: 5.08 mm, color: green, This assembly frame can only be used in combination with IC 2,5/...-STGF-5,08

Your advantages

- ✓ Feed-through assembly frame for inverted COMBICON connector IC 2,5/-STGF-5,08
- ✓ Cable connection on the inside of the device enables flexible positioning of the panel feed-through
- ✓ Mounting flanges reduce the mechanical strain on the soldering spots
- ✓ Can be combined with the MSTB 2,5 range



Key Commercial Data

Packing unit	1 pc
Minimum order quantity	50 pc
GTIN	 4 017918 108939
GTIN	4017918108939
Weight per Piece (excluding packing)	1.984 g
Custom tariff number	39269097
Country of origin	Poland

Technical data

Dimensions

Length	19 mm
Height	16.75 mm
Width	49.07 mm
Pitch	5.08 mm
Dimension a	27.22 mm

Accessories - IC-DFR 5 - 1852053

Technical data

General

Range of articles	IC-DFR
Insulating material group	I
Nominal cross section	2.5 mm ²
Insulating material	PA
Flammability rating according to UL 94	V0
Number of positions	5

Standards and Regulations

Flammability rating according to UL 94	V0
--	----

Environmental Product Compliance

China RoHS	Environmentally friendly use period: unlimited = EFUP-e
	No hazardous substances above threshold values

Drawings

Drilling diagram

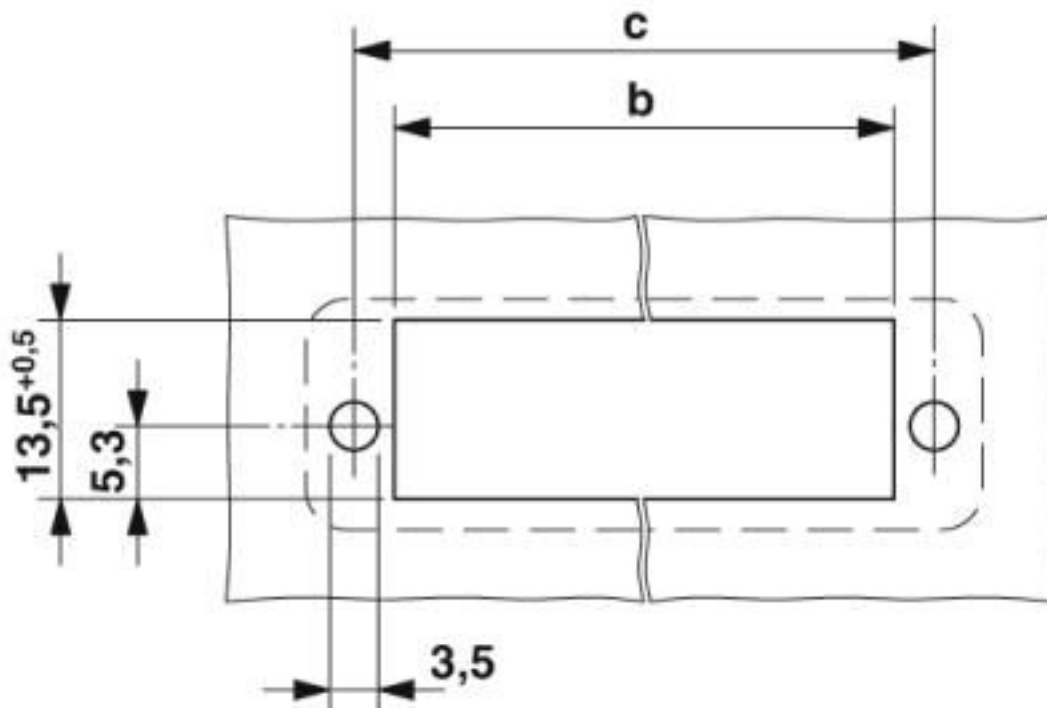

Dimension b: 10.84 mm + (no. of pos. x 5.08 mm)

Dimension c: Dim. b + 5.83 mm

Accessories - IC-DFR 5 - 1852053

Dimensional drawing

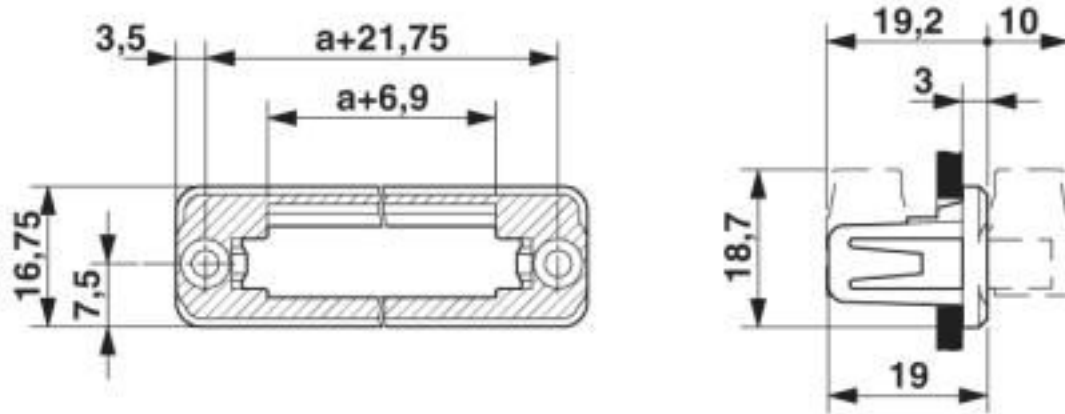

Classifications

eCl@ss

eCl@ss 10.0.1	27440210
eCl@ss 4.0	27260700
eCl@ss 4.1	27260700
eCl@ss 5.0	27260700
eCl@ss 5.1	27260700
eCl@ss 6.0	27261200
eCl@ss 7.0	27440210
eCl@ss 8.0	27440210
eCl@ss 9.0	27440210

ETIM

ETIM 3.0	EC000879
ETIM 4.0	EC000879
ETIM 5.0	EC002310
ETIM 6.0	EC002310
ETIM 7.0	EC002310

UNSPSC

UNSPSC 6.01	30211810
UNSPSC 7.0901	39121409
UNSPSC 11	39121409
UNSPSC 12.01	39121409
UNSPSC 13.2	39121421
UNSPSC 18.0	39121421

Accessories - IC-DFR 5 - 1852053

Classifications

UNSPSC

UNSPSC 19.0	39121421
UNSPSC 20.0	39121421
UNSPSC 21.0	39121421

Approvals

Approvals

Approvals

EAC

Ex Approvals

Approval details

EAC		B.01687
-----	--	---------

Accessories

Accessories

Mounting material

Screw set - DFK-MSTB-SS - 0708263



Screw set, for securing the header to the device wall, consists of an M3 x 10 screw, with a spring washer and a nut

PCB plug

Accessories - IC-DFR 5 - 1852053

Accessories

Printed-circuit board connector - IC 2,5/ 5-STGF-5,08 - 1825530



PCB connector, nominal current: 12 A, rated voltage (III/2): 320 V, nominal cross section: 2.5 mm², number of positions: 5, pitch: 5.08 mm, connection method: Screw connection with tension sleeve, color: green, contact surface: Tin