

PCB terminal block - MKDS 3/ 9 - 1733842

Please be informed that the data shown in this PDF Document is generated from our Online Catalog. Please find the complete data in the user's documentation. Our General Terms of Use for Downloads are valid (<http://phoenixcontact.com/download>)



PCB terminal block, nominal current: 24 A, rated voltage (III/2): 400 V, nominal cross section: 2.5 mm², pitch: 5 mm, number of positions: 9, connection method: Screw connection with tension sleeve, mounting: Wave soldering, conductor/PCB connection direction: 0 °, color: green, Pin layout: Linear pinning, Solder pin [P]: 5 mm. The article can be aligned to create different nos. of positions!

The figure shows a 4-position version

Your advantages

- ✓ Well-known connection principle allows worldwide use
- ✓ Low temperature rise, thanks to maximum contact force
- ✓ Allows connection of two conductors
- ✓ Integrated protective guide prevents incorrect insertion of the conductor underneath the tension sleeve
- ✓ The latching on the side enables various numbers of positions to be combined



Key Commercial Data

Packing unit	1 pc
Minimum order quantity	50 pc
GTIN	 4 017918 329969
GTIN	4017918329969
Weight per Piece (excluding packing)	18.000 g
Custom tariff number	85369010
Country of origin	Germany

Technical data

Item properties

Brief article description	PCB terminal block
Range of articles	MKDS 3
Pitch	5 mm

PCB terminal block - MKDS 3/ 9 - 1733842

Technical data

Item properties

Number of positions	9
Connection method	Screw connection with tension sleeve
Drive form screw head	Slotted (L)
Screw thread	M3
Mounting type	Wave soldering
Pin layout	Linear pinning
Number of levels	1
Number of connections	9
Number of potentials	9

Electrical parameters

Nominal current	24 A
Nom. voltage	400 V
Rated voltage	250 V
Rated voltage (III/2)	400 V
Rated voltage (II/2)	630 V
Rated surge voltage (III/3)	4 kV
Rated surge voltage (III/2)	4 kV
Rated surge voltage (II/2)	4 kV

Connection capacity

Connection method	Screw connection with tension sleeve
pluggable	Yes
Conductor cross section solid	0.2 mm ² ... 4 mm ²
Conductor cross section flexible	0.2 mm ² ... 2.5 mm ²
Conductor cross section AWG / kcmil	24 ... 12
Conductor cross section flexible, with ferrule without plastic sleeve	0.25 mm ² ... 2.5 mm ²
Conductor cross section, flexible, with ferrule, with plastic sleeve	0.25 mm ² ... 2.5 mm ²
2 conductors with same cross section, solid	0.2 mm ² ... 1.5 mm ²
2 conductors with same cross section, flexible	0.2 mm ² ... 1.5 mm ²
2 conductors with same cross section, flexible, with ferrule without plastic sleeve	0.25 mm ² ... 0.75 mm ²
2 conductors with the same cross section, flexible, with TWIN ferrule with plastic sleeve	0.5 mm ² ... 1.5 mm ²
Stripping length	8 mm
Torque	0.5 Nm ... 0.6 Nm

Material data - contact

Note	WEEE/RoHS-compliant, free of whiskers according to IEC 60068-2-82/ JEDEC JESD 201
------	-----------------------------------------------------------------------------------

PCB terminal block - MKDS 3/ 9 - 1733842

Technical data

Material data - contact

Contact material	Cu alloy
Surface characteristics	Tin-plated
Metal surface terminal point (top layer)	Tin (4 - 8 µm Sn)
Metal surface soldering area (top layer)	Tin (4 - 8 µm Sn)

Material data - housing

Housing color	green (6021)
Insulating material	PA
Insulating material group	I
CTI according to IEC 60112	600
Flammability rating according to UL 94	V0
Glow wire flammability index GWFI according to EN 60695-2-12	850
Glow wire ignition temperature GWIT according to EN 60695-2-13	775
Temperature for the ball pressure test according to EN 60695-10-2	125 °C

Dimensions for the product

Caption	Schematic representation – for additional information, see product range drawing in the Download Center
Length [l]	11.2 mm
Width [w]	45 mm
Height [h]	23 mm
Pitch	5 mm
Height (without solder pin)	18 mm
Solder pin [P]	5 mm
Pin spacing	5 mm
Pin dimensions	0.9 x 0.9 mm

Dimensions for PCB design

Hole diameter	1.3 mm
Pin spacing	5 mm

Packaging information

Type of packaging	packed in cardboard
Pieces per package	50
Denomination packing units	Pcs.

General product information

Type of note	Note on application
Note	For safe conductor connection, always adhere to a defined tightening torque. Particularly in the case of PCB terminal blocks with two or three positions, the individual solder pin for each contact point cannot

PCB terminal block - MKDS 3/ 9 - 1733842

Technical data

General product information

	compensate for this. That is why the terminal blocks must be supported during conductor connection (held with one hand, support on the housing).
--	--------------------------------------------------------------------------------------------------------------------------------------------------

Ambient conditions

Ambient temperature (storage/transport)	-40 °C ... 70 °C
Ambient temperature (assembly)	-5 °C ... 100 °C
Ambient temperature (operation)	-40 °C ... 100 °C (Depending on the current carrying capacity/derating curve)

Termination and connection method

Test for conductor damage and slackening	IEC 60998-2-1:2002-12
	Test passed

Pull-out test

Pull-out test	IEC 60998-2-1:2002-12
	Test passed
Conductor cross section / conductor type / tensile force	0.2 mm ² / solid / > 10 N
	0.2 mm ² / flexible / > 10 N
	4 mm ² / solid / > 60 N
	2.5 mm ² / flexible / > 50 N

Mechanical tests according to standard

Test specification	IEC 60998-2-1 (in parts)
--------------------	--------------------------

Electrical tests

Rated current	24 A
Conductor cross section	2.5 mm ²
Rated voltage (III/2)	400 V
Rated surge voltage (III/2)	4 kV

Air clearances and creepage distances

Clearances and creepage distances	IEC 60947-1:2007-06 + A1:2010-12 + A2:2014-09
Specification	IEC 60947-1:2007-06 + A1:2010-12 + A2:2014-09
Minimum clearance - inhomogeneous field (III/3)	3 mm
Minimum clearance - inhomogeneous field (III/2)	3 mm
Minimum clearance - inhomogeneous field (II/2)	3 mm
Minimum creepage distance value (III/3)	3.2 mm
Minimum creepage distance value (III/2)	3 mm
Minimum creepage distance value (II/2)	3.2 mm
Note on connection cross section	With connected conductor 4 mm ² (solid).

Temperature-rise test

PCB terminal block - MKDS 3/ 9 - 1733842

Technical data

Temperature-rise test

Result	Test passed
Specification	IEC 60998-1:2002-12

Current carrying capacity / derating curves

Specification	IEC 60998-2-1 (in parts)
---------------	--------------------------

Vibration test

Specification	IEC 60068-2-6:1995-03
Result	Test passed
Frequency	10 - 150 - 10 Hz
Sweep speed	1 octave/min
Amplitude	0.35 mm (10 - 60.1 Hz)
Acceleration	5 g (60.1 - 150 Hz)
Test duration per axis	2.5 h

Resistance to ageing, humidity and penetration of solids

Dry heat	168 h/100°C
Humid heat	48 h/30 °C/92 %

Standards and Regulations

Connection in acc. with standard	EN-VDE
	CSA
Flammability rating according to UL 94	V0

Environmental Product Compliance

REACH SVHC	Lead 7439-92-1
China RoHS	Environmentally Friendly Use Period = 50 years
	For details about hazardous substances go to tab "Downloads", Category "Manufacturer's declaration"

Drawings

PCB terminal block - MKDS 3/ 9 - 1733842

Drilling diagram

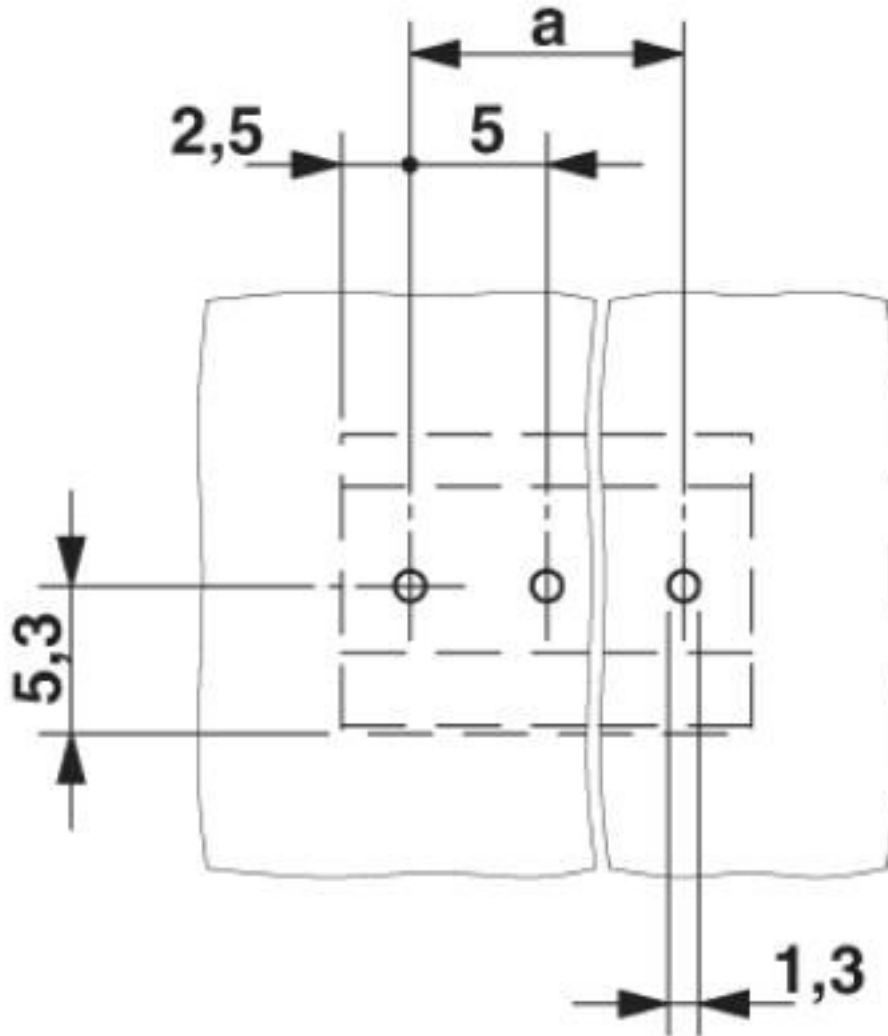

PCB terminal block - MKDS 3/ 9 - 1733842

Dimensional drawing

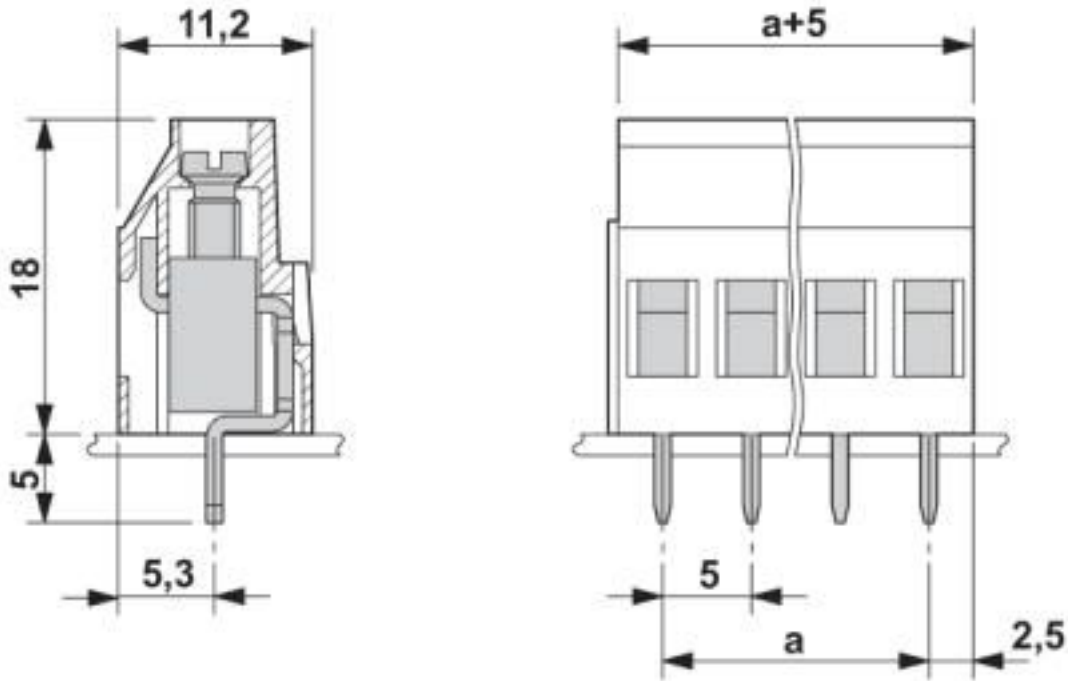

Classifications

eCl@ss

eCl@ss 10.0.1	27440401
eCl@ss 4.0	27141100
eCl@ss 4.1	27141100
eCl@ss 5.0	27141100
eCl@ss 5.1	27261100
eCl@ss 6.0	27261100
eCl@ss 7.0	27440401
eCl@ss 8.0	27440401
eCl@ss 9.0	27440401

ETIM

ETIM 3.0	EC001121
ETIM 4.0	EC002643
ETIM 5.0	EC002643
ETIM 6.0	EC002643
ETIM 7.0	EC002643

PCB terminal block - MKDS 3/ 9 - 1733842

Classifications

UNSPSC

UNSPSC 6.01	30211801
UNSPSC 7.0901	39121432
UNSPSC 11	39121432
UNSPSC 12.01	39121432
UNSPSC 13.2	39121432
UNSPSC 18.0	39121432
UNSPSC 19.0	39121432
UNSPSC 20.0	39121432
UNSPSC 21.0	39121432

Approvals

Approvals

Approvals

DNV GL / CSA / SEV / EAC / cULus Recognized / IECCEB Scheme

Ex Approvals

Approval details

DNV GL		https://approvalfinder.dnvgl.com/	TAE00001EV
--------	-------------------------------------------------------------------------------------	-----------------------------------------------------------------------------------	------------

CSA		http://www.csagroup.org/services-industries/product-listing/	13631
	B	D	
Nominal voltage UN	300 V	300 V	
Nominal current IN	10 A	10 A	
mm ² /AWG/kcmil	28-12	28-12	

PCB terminal block - MKDS 3/ 9 - 1733842

Approvals

SEV		https://www.eurofins.ch/de/	IK-4497
Nominal voltage UN		250 V	
Nominal current IN		28 A	
mm ² /AWG/kcmil		4	

EAC		B.01687
-----	-----------------------------------------------------------------------------------	---------

cULus Recognized		http://database.ul.com/cgi-bin/XYV/template/LISEXT/1FRAME/index.htm	E60425-19770427
	B	D	
Nominal voltage UN	300 V	300 V	
Nominal current IN	15 A	10 A	
mm ² /AWG/kcmil	30-12	30-12	

IECEE CB Scheme		http://www.iecee.org/	CH-10787
Nominal voltage UN		250 V	
Nominal current IN		32 A	
mm ² /AWG/kcmil		4	

Accessories

Accessories

Bridge

Insertion bridge - EBP 2- 5 - 1733169

Insertion bridge for connectors with 5.0 mm or 5.08 mm pitch



PCB terminal block - MKDS 3/ 9 - 1733842

Accessories

Insertion bridge - EBP 3- 5 - 1733172



Insertion bridge for connectors with 5.0 mm or 5.08 mm pitch

Insertion bridge - EBP 4- 5 - 1733185



Insertion bridge for connectors with 5.0 mm or 5.08 mm pitch

Insertion bridge - EBP 5- 5 - 1733198



Insertion bridge for connectors with 5.0 mm or 5.08 mm pitch

Insertion bridge - EBP 6- 5 - 1733208



Insertion bridge for connectors with 5.0 mm or 5.08 mm pitch

Labeled terminal marker

Marker card - SK 5/3,8:FORTL.ZAHLEN - 0804183



Marker card, Card, white, labeled, horizontal: consecutive numbers 1 ... 10, 11 ... 20, etc. up to 91 ... (99)100, mounting type: adhesive, for terminal block width: 5 mm, lettering field size: 5 x 3.8 mm

PCB terminal block - MKDS 3/ 9 - 1733842

Accessories

Marker pen

Marker pen - B-STIFT - 1051993



Marker pen, for manual labeling of unprinted Zack strips, smear-proof and waterproof, line thickness 0.5 mm

Pitch spacer

Pitch spacer - RZ 1,25-MKDS 3 - 1703047



Pitch spacer, for adjusting the pitches between MKDS and GMKDS terminal blocks in mixed rows, 1.25 mm thick

Screwdriver tools

Screwdriver - SZS 0,6X3,5 - 1205053



Actuation tool, for ST terminal blocks, insulated, also suitable for use as a bladed screwdriver, size: 0.6 x 3.5 x 100 mm, 2-component grip, with non-slip grip

Terminal marking

Marker card - SK 5/3,8:UNBEDRUCKT - 0805409



Marker card, Card, white, unlabeled, can be labeled with: Marker pen, mounting type: adhesive, for terminal block width: 5 mm, lettering field size: 5 x 3.8 mm

PCB terminal block - MKDS 3/ 9 - 1733842

Accessories

Marker card - SK U/3,8 WH:UNBEDRUCKT - 0803906



Marker card, Sheet, white, unlabeled, can be labeled with: PLOTMARK, CMS-P1-PLOTTER, Office printing systems, mounting type: adhesive, for terminal block width: 210 mm, lettering field size: 186 x 3.8 mm, Number of individual labels: 1440