

PCB terminal block - ZFKDSA 4-10- 2 - 1722545

Please be informed that the data shown in this PDF Document is generated from our Online Catalog. Please find the complete data in the user's documentation. Our General Terms of Use for Downloads are valid (<http://phoenixcontact.com/download>)



PCB terminal block, nominal current: 32 A, rated voltage (III/2): 630 V, nominal cross section: 4 mm², pitch: 10 mm, number of positions: 2, connection method: Spring-cage connection, mounting: Wave soldering, conductor/PCB connection direction: 45 °, color: green, Pin layout: Linear pinning, Solder pin [P]: 4.6 mm

The figure shows a 5-pos. version of the product

Your advantages

- Defined contact force ensures that contact remains stable over the long term
- Clamping space opened by means of fixed screwdriver enables convenient conductor connection
- Separate bridge shaft for easily connecting multiple positions to jumpers
- Quick and convenient testing using integrated test option



Key Commercial Data

Packing unit	1
GTIN	
GTIN	4046356116534
Custom tariff number	85369010

Technical data

Item properties

Brief article description	PCB terminal block
Range of articles	ZFKDS(A) 4
Pitch	10 mm
Number of positions	2
Connection method	Spring-cage connection
Mounting type	Wave soldering
Pin layout	Linear pinning

PCB terminal block - ZFKDSA 4-10- 2 - 1722545

Technical data

Item properties

Number of levels	1
Number of connections	2
Number of potentials	2

Electrical parameters

Nominal current	32 A
Nom. voltage	630 V
Rated voltage	630 V
Rated voltage (III/2)	630 V
Rated voltage (II/2)	1000 V
Rated surge voltage (III/3)	6 kV
Rated surge voltage (III/2)	6 kV
Rated surge voltage (II/2)	6 kV

Connection capacity

Connection method	Spring-cage connection
pluggable	Yes
Conductor cross section solid	0.2 mm ² ... 6 mm ²
Conductor cross section flexible	0.2 mm ² ... 4 mm ²
Conductor cross section AWG / kcmil	24 ... 10
Conductor cross section flexible, with ferrule without plastic sleeve	0.25 mm ² ... 4 mm ²
Conductor cross section, flexible, with ferrule, with plastic sleeve	0.25 mm ² ... 4 mm ²
Stripping length	10 mm

Material data - contact

Note	WEEE/RoHS-compliant, free of whiskers according to IEC 60068-2-82/ JEDEC JESD 201
Contact material	Cu alloy
Surface characteristics	Tin-plated
Metal surface terminal point (top layer)	Tin (10 - 16 µm Sn)
Metal surface soldering area (top layer)	Tin (10 - 16 µm Sn)

Material data - housing

Housing color	green (6021)
Insulating material	PA
Insulating material group	I
CTI according to IEC 60112	600
Flammability rating according to UL 94	V0
Glow wire flammability index GWFI according to EN 60695-2-12	850
Glow wire ignition temperature GWIT according to EN 60695-2-13	775

PCB terminal block - ZFKDSA 4-10- 2 - 1722545

Technical data

Material data - housing

Temperature for the ball pressure test according to EN 60695-10-2	125 °C
---	--------

Dimensions for the product

Length [l]	29 mm
Width [w]	21.5 mm
Height [h]	27.6 mm
Pitch	10 mm
Height (without solder pin)	23 mm
Solder pin [P]	4.6 mm
Pin dimensions	1 x 1.4 mm

Dimensions for PCB design

Hole diameter	1.8 mm
---------------	--------

Packaging information

Type of packaging	packed in cardboard
Pieces per package	50
Denomination packing units	Pcs.

Ambient conditions

Ambient temperature (storage/transport)	-40 °C ... 70 °C
Ambient temperature (assembly)	-5 °C ... 100 °C
Ambient temperature (operation)	-40 °C ... 100 °C (Depending on the current carrying capacity/derating curve)

Termination and connection method

Connection test	IEC 60998-2-2:1991-10
Test result	Test passed
Test for conductor damage and slackening	IEC 60998-2-2:1991-10
	Test passed

Pull-out test

Pull-out test	IEC 60998-2-2:1991-10
	Test passed
Conductor cross section / conductor type / tensile force	0.2 mm ² / solid / > 10 N
	0.2 mm ² / flexible / > 10 N
	6 mm ² / solid / > 80 N
	4 mm ² / flexible / > 60 N

Mechanical tests according to standard

Test specification	IEC 60998-2-2 (in parts)
--------------------	--------------------------

PCB terminal block - ZFKDSA 4-10- 2 - 1722545

Technical data

Electrical tests

Rated current	32 A
Conductor cross section	4 mm ²
Rated voltage (III/2)	630 V
Rated surge voltage (III/2)	6 kV

Air clearances and creepage distances

Clearances and creepage distances	IEC 60664-1:2007-04
Specification	IEC 60664-1:2007-04
Minimum clearance - inhomogeneous field (III/3)	5.5 mm
Minimum clearance - inhomogeneous field (III/2)	5.5 mm
Minimum clearance - inhomogeneous field (II/2)	5.5 mm
Minimum creepage distance value (III/3)	8 mm
Minimum creepage distance value (III/2)	5.5 mm
Minimum creepage distance value (II/2)	5.5 mm

Temperature-rise test

Result	Test passed
Specification	IEC 60998-2-1:1990-04

Current carrying capacity / derating curves

Specification	IEC 60998-2-2 (in parts)
---------------	--------------------------

Vibration test

Specification	IEC 60068-2-6:1995-03
Result	Test passed
Frequency	10 - 150 - 10 Hz
Sweep speed	1 octave/min
Amplitude	0.35 mm (10 - 60.1 Hz)
Acceleration	5 g (60.1 - 150 Hz)
Test duration per axis	2.5 h

Resistance to ageing, humidity and penetration of solids

Dry heat	168 h/100°C
Humid heat	48 h/30 °C/92 %

Standards and Regulations

Connection in acc. with standard	EN-VDE
	CUL
Flammability rating according to UL 94	V0

Environmental Product Compliance

PCB terminal block - ZFKDSA 4-10- 2 - 1722545

Technical data

Environmental Product Compliance

China RoHS	Environmentally friendly use period: unlimited = EFUP-e
	No hazardous substances above threshold values

Drawings

Drilling diagram

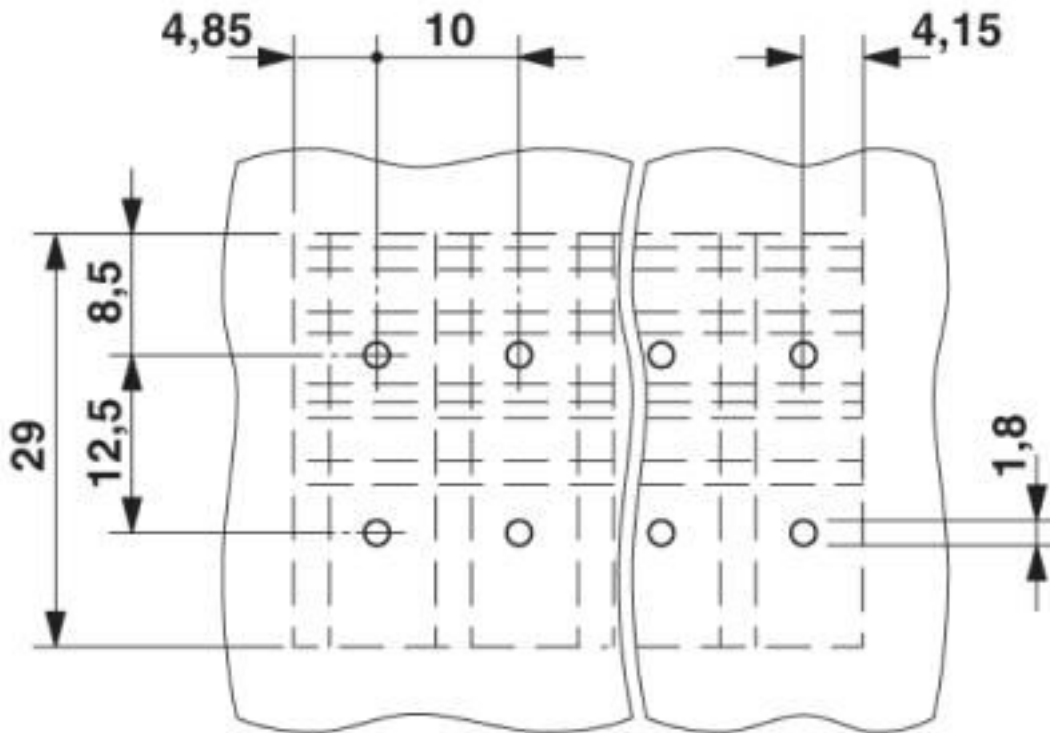

PCB terminal block - ZFKDSA 4-10- 2 - 1722545

Diagram

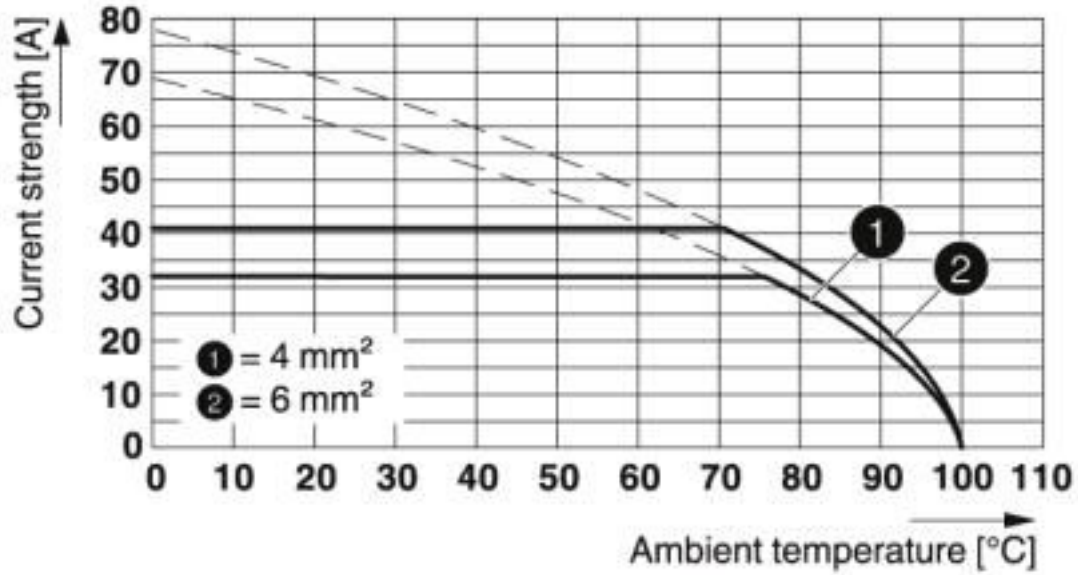

Type: ZFKDS 4-10
Test according to DIN EN 60947-7-4 (VDE 0611-7-4):2014-08
Illustration according to DIN EN 60512-5-2:2003-01
Reduction factor = 1
Number of positions: 4

Dimensional drawing

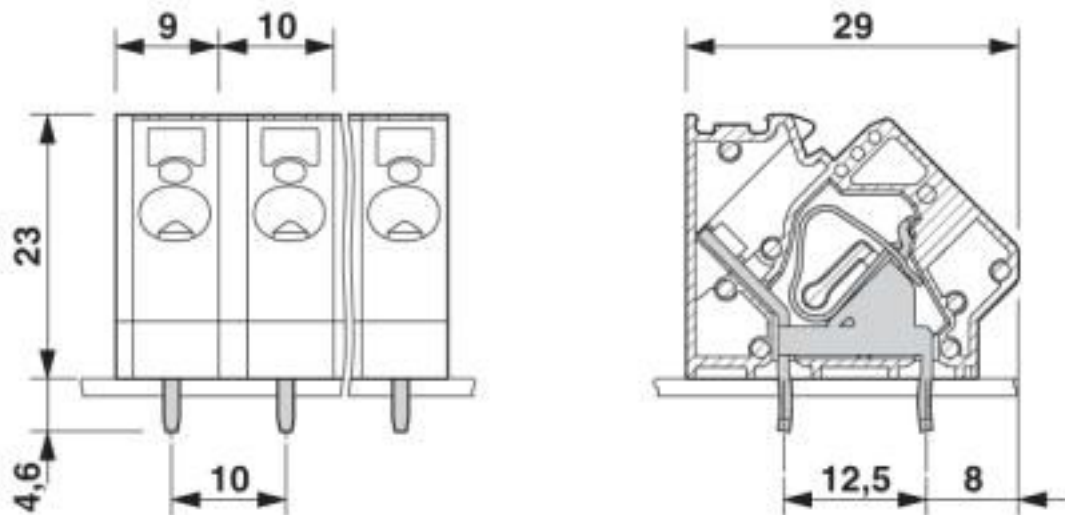

PCB terminal block - ZFKDSA 4-10- 2 - 1722545

Classifications

eCl@ss

eCl@ss 10.0.1	27440401
eCl@ss 4.0	27141100
eCl@ss 4.1	27141100
eCl@ss 5.0	27141100
eCl@ss 5.1	27261100
eCl@ss 6.0	27261100
eCl@ss 7.0	27440401
eCl@ss 8.0	27440401
eCl@ss 9.0	27440401

ETIM

ETIM 3.0	EC001121
ETIM 4.0	EC002643
ETIM 5.0	EC002643
ETIM 6.0	EC002643
ETIM 7.0	EC002643

UNSPSC

UNSPSC 6.01	30211801
UNSPSC 7.0901	39121432
UNSPSC 11	39121432
UNSPSC 12.01	39121432
UNSPSC 13.2	39121432
UNSPSC 18.0	39121432
UNSPSC 19.0	39121432
UNSPSC 20.0	39121432
UNSPSC 21.0	39121432

Approvals

Approvals

Approvals

EAC / cULus Recognized

Ex Approvals

PCB terminal block - ZFKDSA 4-10- 2 - 1722545

Approvals

Approval details

EAC		B.01687
-----	--	---------

cULus Recognized		http://database.ul.com/cgi-bin/XYV/template/LISEXT/1FRAME/index.htm	E60425-19941110
	B	C	D
Nominal voltage UN	300 V	300 V	600 V
Nominal current IN	30 A	30 A	5 A
mm ² /AWG/kcmil	24-10	24-10	24-10

Accessories

Accessories

Crimping tool

Crimping pliers - CRIMPFOX 6 - 1212034



Crimping pliers, for ferrules without insulating collar according to DIN 46228 Part 1 and ferrules with insulating collar according to DIN 46228 Part 4, 0.25 mm² ... 6.0 mm², lateral entry, trapezoidal crimp

Flange

PCB terminal block - FL-ZFKDS 4 - 1928495



Pair of flanges, can be snapped onto a row of single terminal blocks

Labeled terminal marker

PCB terminal block - ZFKDSA 4-10- 2 - 1722545

Accessories

Zack Marker strip, flat - ZBF10 CUS - 0825031



Zack Marker strip, flat, can be ordered: Strip, white, labeled according to customer specifications, mounting type: snap into flat marker groove, for terminal block width: 10 mm, lettering field size: 5.15 x 10 mm, Number of individual labels: 10

Pitch spacer

Pitch spacer - RZ-ZFKDS 4 - 1928521



Pitch spacer, 2.5 mm wide

Screwdriver tools

Screwdriver - SZF 1-0,6X3,5 - 1204517



Actuation tool, for ST terminal blocks, also suitable for use as a bladed screwdriver, size: 0.6 x 3.5 x 100 mm, 2-component grip, with non-slip grip

Terminal marking

Zack Marker strip, flat - ZBF10:UNBEDRUCKT - 0809997



Zack Marker strip, flat, Strip, white, unlabeled, can be labeled with: CMS-P1-PLOTTER, PLOTMARK, mounting type: snap into flat marker groove, for terminal block width: 10 mm, lettering field size: 5.15 x 10 mm, Number of individual labels: 10

PCB terminal block - ZFKDSA 4-10- 2 - 1722545

Accessories

Marker card - SK U/5,0 WH:UNBEDRUCKT - 0803922



Marker card, Sheet, white, unlabeled, can be labeled with: PLOTMARK, CMS-P1-PLOTTER, Office printing systems, mounting type: adhesive, for terminal block width: 210 mm, lettering field size: 186 x 5 mm, Number of individual labels: 630

Test plug terminal block

Test plugs - MPS-MT - 0201744



Test plugs, with solder connection up to 1 mm² conductor cross section, color: gray