

Contact insert - HC-K 4/8-EBUS - 1679320

Please be informed that the data shown in this PDF Document is generated from our Online Catalog. Please find the complete data in the user's documentation. Our General Terms of Use for Downloads are valid (<http://phoenixcontact.com/download>)



HEAVYCON female insert, K4/8 series, for 4 power and 8 control contacts, screw connection without wire protection



COMPLETE

Key Commercial Data

Packing unit	1 pc
GTIN	 4 017918 163563
GTIN	4017918163563
Weight per Piece (excluding packing)	148.500 g
Custom tariff number	85366990
Country of origin	China

Technical data

General

Note	For housing HC-B24
	Connectors may be operated only when there is no load/voltage.
Connection method	Screw connection (power contacts) Screw connection (control contacts)
Tightening torque	2 Nm (Power contact, 2.5 mm ²) 3 Nm (Power contact, 4 ... 16 mm ²) 1.2 Nm (Power contact, 1.5 mm ²) 0.5 Nm (control contacts)
Torque	0.8 Nm ... 1.2 Nm (PE connection) 0.5 Nm ... 0.8 Nm (Mounting screws for mounting in the HEAVYCON housing)

Contact insert - HC-K 4/8-EBUS - 1679320

Technical data

General

Screwdriver blade	0.8 x 4.5 mm (power contacts)
	0.5 x 3.5 mm (control contacts)
Degree of pollution	3
Overvoltage category	III
Number of positions	4+8+2PE
No. of power contacts	4
No. of control contacts	8
Insertion/withdrawal cycles	≥ 500
Size	B24
	B48
Contact numbering	1 - 4
Conductor cross section	1.5 mm ² ... 16 mm ² (power contacts)
	0.5 mm ² ... 2.5 mm ² (control contacts)
Connection cross section AWG	16 ... 6 (power contacts)
	20 ... 14 (control contacts)
Stripping length of the individual wire	14 mm (Power contact)
	7 mm (control contact)
Assembly instructions	To ensure correct use, installation in housing with IP54 protection or better is required
Connection	Use wire end protection (screw connections do not have wire protection)

Ambient conditions

Ambient temperature (operation)	-40 °C ... 125 °C
---------------------------------	-------------------

Material data

Contact material	Copper alloy
Contact surface material	Ag (alternatively Au)
Material of contact surface, power contact	Ag
Material of contact surface, control contact	Ag
Contact carrier material	PA
Standards/regulations	PC: Fire protection in rail vehicles - requirement sets R22, R23, and R24 acc. to DIN EN 45545-2 (Risk level HL1 - HL3)

Electrical characteristics

Rated voltage (III/3)	400 V (power contacts)
	400 V (control contacts)
Rated surge voltage	6 kV (power contacts)
	6 kV (control contacts)
Rated current	80 A (power contacts)
	16 A (control contacts)

Contact insert - HC-K 4/8-EBUS - 1679320

Technical data

Standards and Regulations

Connection in acc. with standard	CSA
Flammability rating according to UL 94	V0

Environmental Product Compliance

China RoHS	Environmentally Friendly Use Period = 50 years
	For details about hazardous substances go to tab "Downloads", Category "Manufacturer's declaration"

Drawings

Contact insert - HC-K 4/8-EBUS - 1679320

Schematic diagram

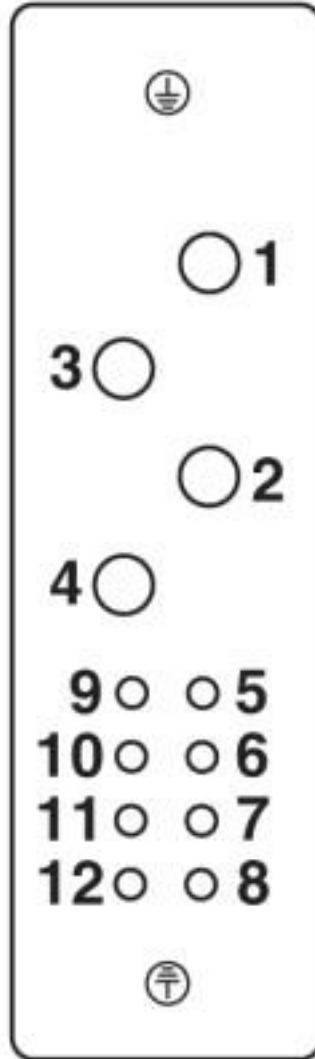

Connector pin assignment, connection side

Contact insert - HC-K 4/8-EBUS - 1679320

Diagram

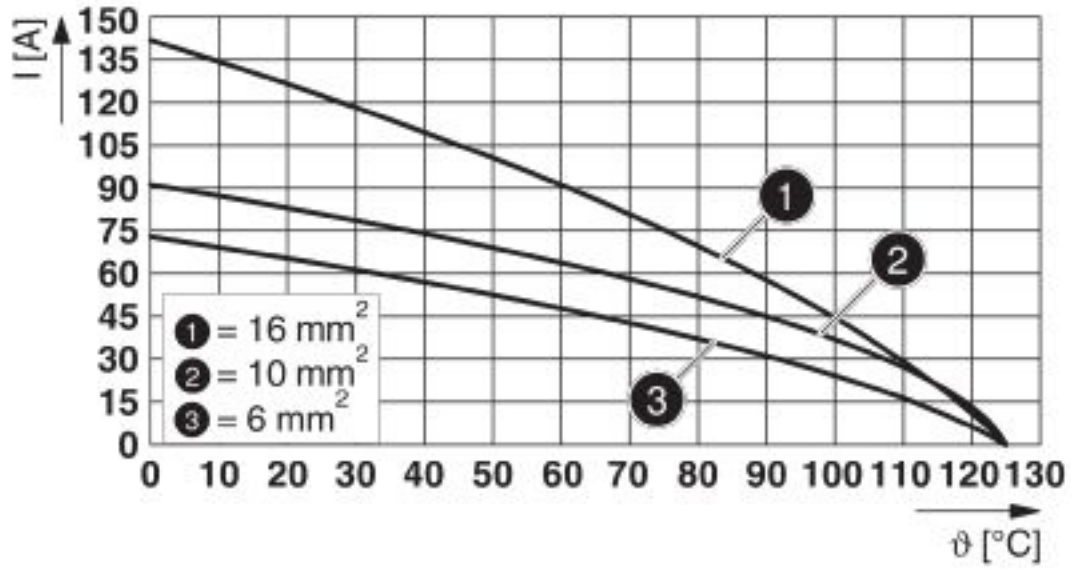

Derating diagram

Dimensional drawing

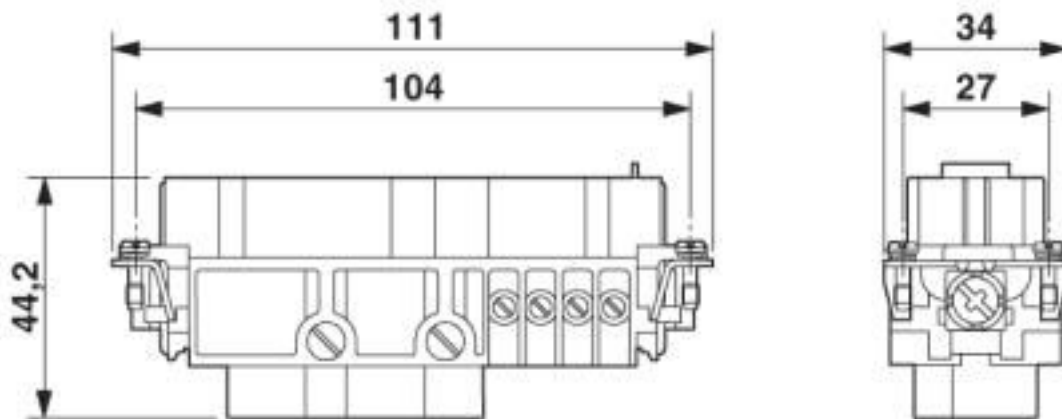

Female insert

Contact insert - HC-K 4/8-EBUS - 1679320

Dimensional drawing

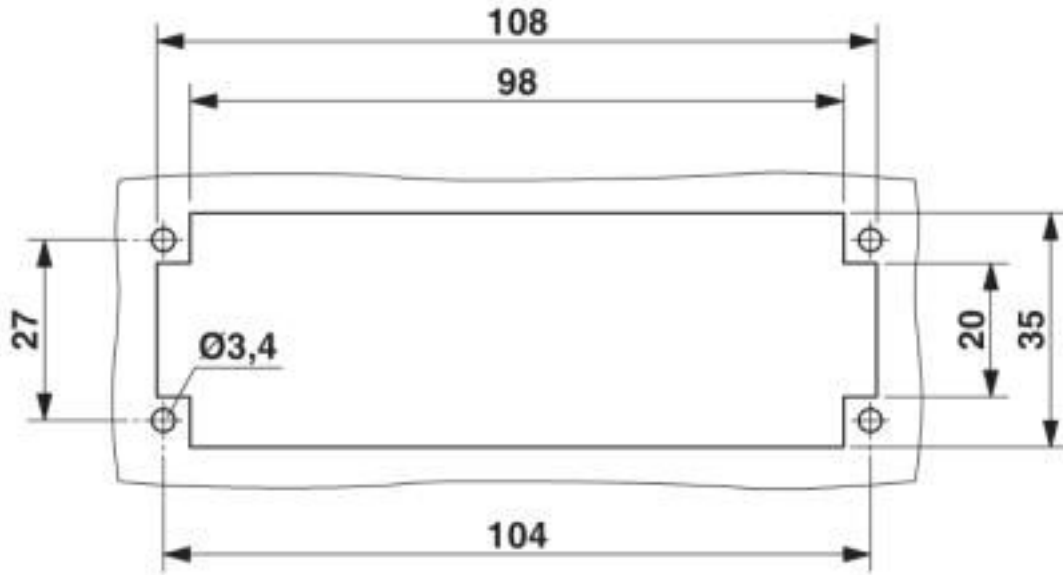

Mounting cutout when used without housing

Classifications

eCl@ss

eCl@ss 10.0.1	27440205
eCl@ss 4.0	27140800
eCl@ss 4.1	27140800
eCl@ss 5.0	27143400
eCl@ss 5.1	27261200
eCl@ss 6.0	27261200
eCl@ss 7.0	27440205
eCl@ss 8.0	27440205
eCl@ss 9.0	27440205

ETIM

ETIM 2.0	EC000438
ETIM 3.0	EC000438
ETIM 4.0	EC000438
ETIM 5.0	EC000438
ETIM 6.0	EC000438
ETIM 7.0	EC000438

Contact insert - HC-K 4/8-EBUS - 1679320

Classifications

UNSPSC

UNSPSC 6.01	30211923
UNSPSC 7.0901	39121522
UNSPSC 11	39121522
UNSPSC 12.01	39121522
UNSPSC 13.2	39121522
UNSPSC 18.0	39121522
UNSPSC 19.0	39121522
UNSPSC 20.0	39121522
UNSPSC 21.0	39121522

Approvals

Approvals

Approvals

EAC / EAC / UL Recognized

Ex Approvals

Approval details

EAC		RU C- DE.AI30.B.01102
-----	---	--------------------------

EAC		RU C- DE.BL08.B.00511
-----	---	--------------------------

UL Recognized		http://database.ul.com/cgi-bin/XYV/template/LISEXT/1FRAME/index.htm	E118976
Nominal voltage UN	600 V		
Nominal current IN	16 A		
mm²/AWG/kcmil	14		

Contact insert - HC-K 4/8-EBUS - 1679320

Accessories

Accessories

Screwdriver tools

Screwdriver - SZF 2-0,8X4,0 - 1204520



Actuation tool, for ST terminal blocks, also suitable for use as a bladed screwdriver, size: 0.8 x 4.0 x 100 mm, 2-component grip, with non-slip grip

Screwdriver - SF-SL 0,6X3,5-100 S-VDE - 1212587



Actuation tool, for ST terminal blocks, VDE insulated, with slimmer insulation integrated in the blade, also suitable for use as a bladed screwdriver, size: 0.6 x 3.5 x 100 mm, 2-component grip, with non-slip grip

Additional products

Contact insert - HC-K 4/8-ESTS - 1679333



HEAVYCON male insert, K4/8 series, for 4 power and 8 control contacts, screw connection without wire protection