

Terminal adapter - HC-B 10-A-DT-PEL-M - 1648403

Please be informed that the data shown in this PDF Document is generated from our Online Catalog. Please find the complete data in the user's documentation. Our General Terms of Use for Downloads are valid (<http://phoenixcontact.com/download>)



HEAVYCON terminal adapter, pin insert, B10 series, 10-pos., for the left side of the control cabinet, push-in connection



COMPLETE™

Key Commercial Data

Packing unit	1 pc
GTIN	 4 046356 092128
GTIN	4046356092128
Weight per Piece (excluding packing)	96.050 g
Custom tariff number	85366990
Country of origin	China

Technical data

Dimensions

Drill hole distance, horizontal	57 mm
Height	70.5 mm

Ambient conditions

Degree of protection (IP)	IP20
Ambient temperature (operation)	-40 °C ... 125 °C

Electrical characteristics

Number of positions	10
Rated voltage (III/3)	500 V
Rated surge voltage	6 kV
Rated current	16 A

Terminal adapter - HC-B 10-A-DT-PEL-M - 1648403

Technical data

Mechanical characteristics

Type	B10
Connection method	Push-in connection
Stripping length of the individual wire	10 mm (13 mm if ferrules are used)
Conductor cross section	0.5 mm ² ... 2.5 mm ²
Connection cross section AWG	22 ... 12

General

Note	For HEAVYCON-ADVANCE mounting flange and HEAVYCON panel mounting base of B10 type
	Connectors may be operated only when there is no load/voltage.
Contact material	Copper alloy
Contact surface material	Ag
Contact carrier material	PA
Standards/regulations	PA: Fire protection in rail vehicles - requirement sets R22 and R23 acc. to DIN EN 45545-2 (Risk level HL1 - HL2)
	PA: Fire protection in rail vehicles - requirement set R24 acc. to DIN EN 45545-2 (Risk level HL1 - HL3)
Degree of pollution	3
Overvoltage category	III
Flammability rating according to UL 94	V0
Assembly instructions	To ensure correct use, installation in housing with IP54 protection or better is required
Installation instructions	Connectors may be plugged in only when there is no load/voltage.

Standards and Regulations

Connection in acc. with standard	CSA
Constructional and testing regulations	DIN EN 61984
	DIN EN 60664
	IEC 60352
Flammability rating according to UL 94	V0

Environmental Product Compliance

REACH SVHC	Lead 7439-92-1
China RoHS	Environmentally Friendly Use Period = 50 years
	For details about hazardous substances go to tab "Downloads", Category "Manufacturer's declaration"

Drawings

Terminal adapter - HC-B 10-A-DT-PEL-M - 1648403

Dimensional drawing

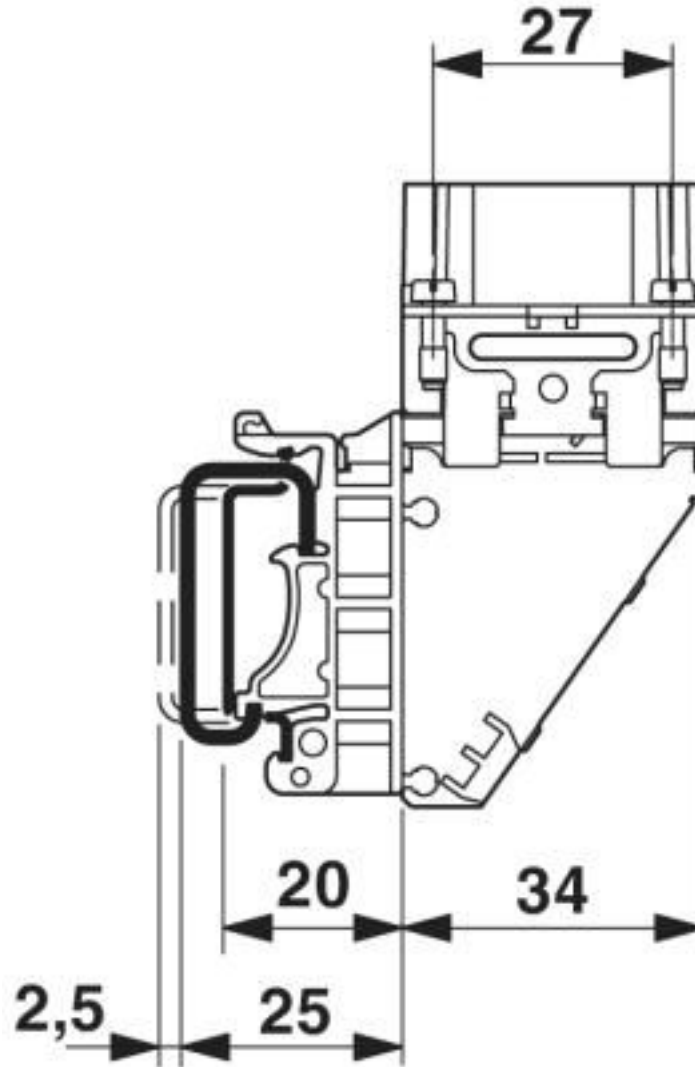

Dimensional drawing, side view

Terminal adapter - HC-B 10-A-DT-PEL-M - 1648403

Dimensional drawing

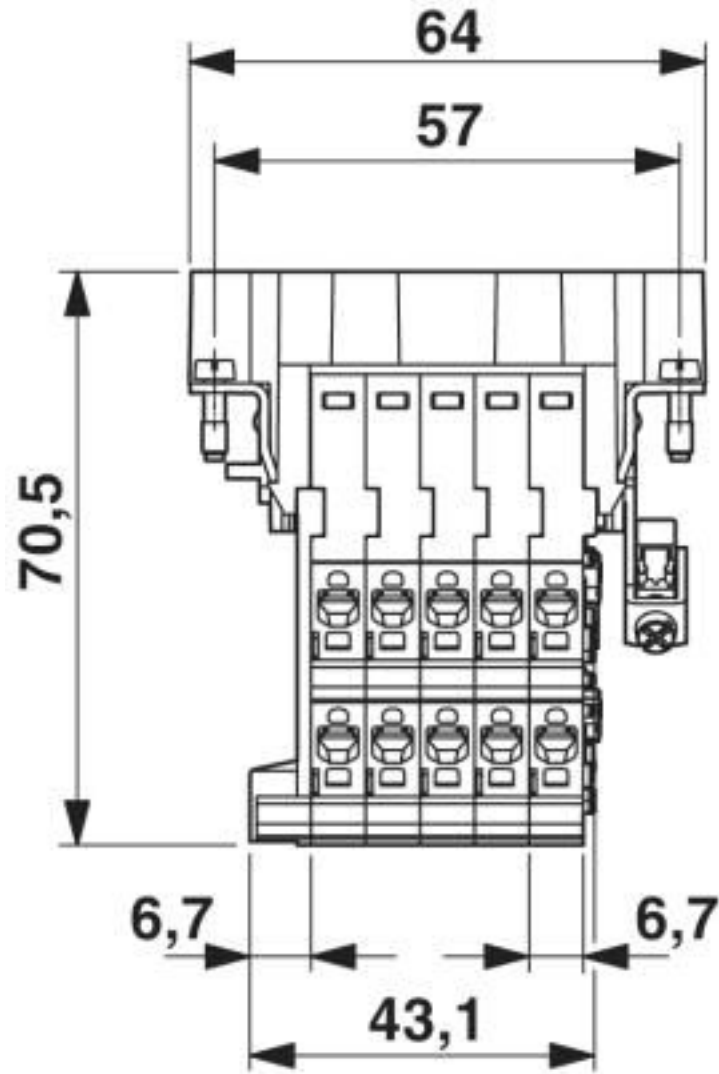

Dimensional drawing

Terminal adapter - HC-B 10-A-DT-PEL-M - 1648403

Application drawing

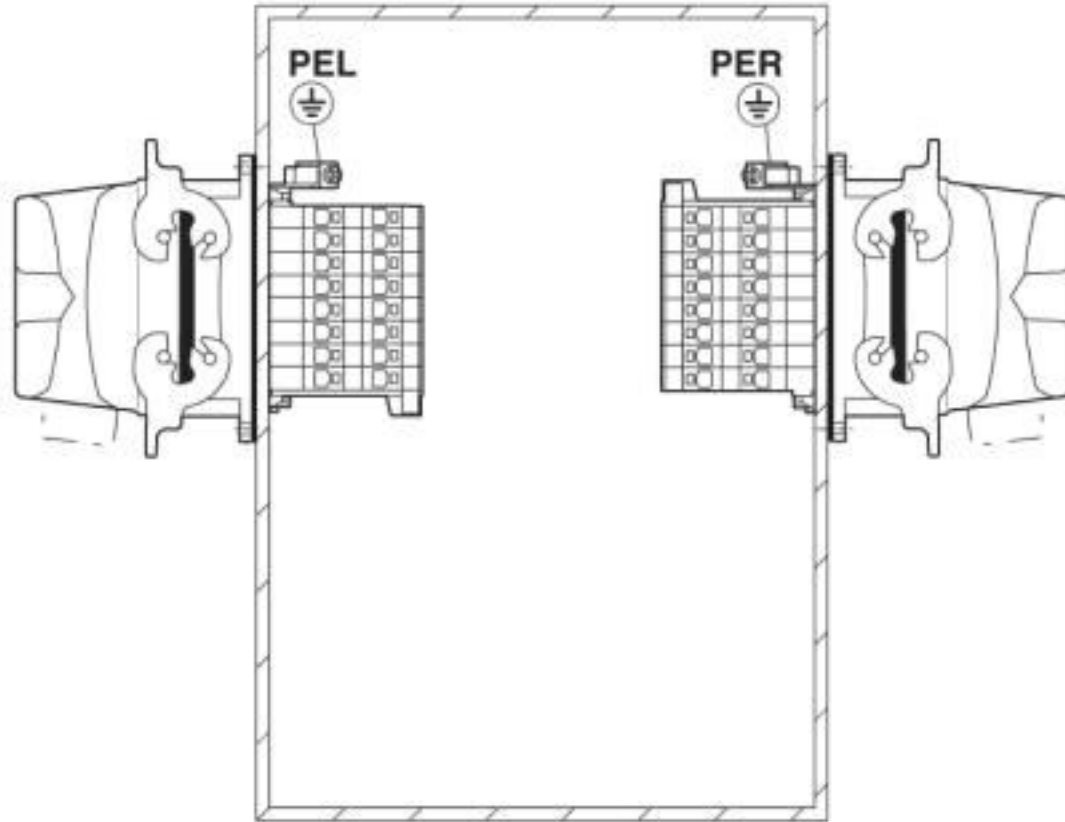

Mounting position PE connection left/right (PEL/PER)

Terminal adapter - HC-B 10-A-DT-PEL-M - 1648403

Diagram

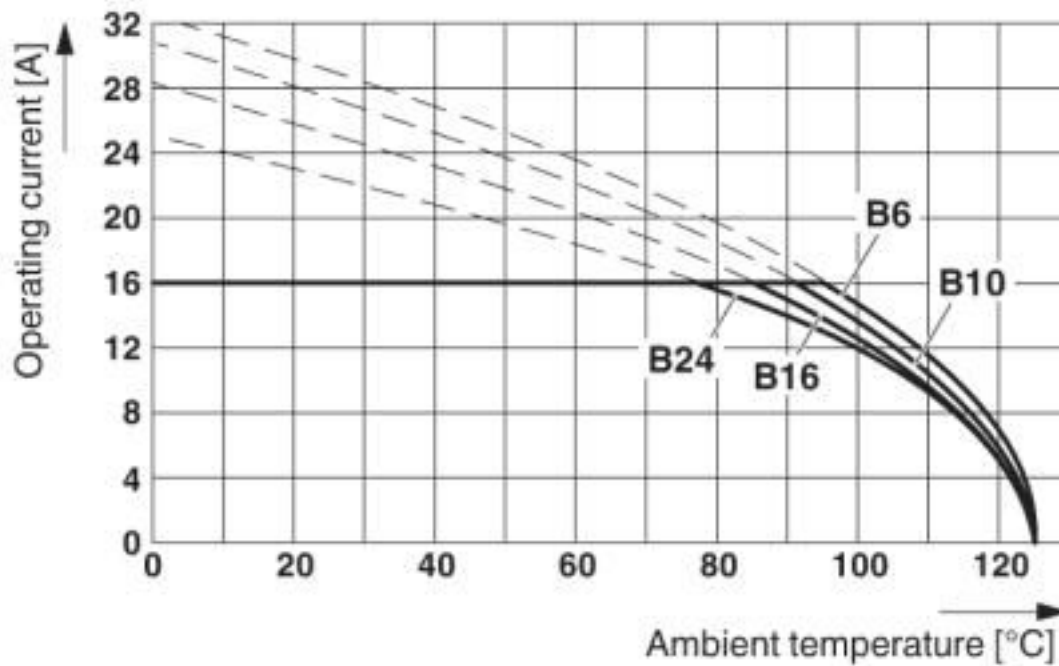

Derating diagram

Classifications

eCl@ss

eCl@ss 10.0.1	27440222
eCl@ss 4.0	27140800
eCl@ss 4.1	27140800
eCl@ss 5.0	27143400
eCl@ss 5.1	27261200
eCl@ss 6.0	27261200
eCl@ss 7.0	27440205
eCl@ss 8.0	27440205
eCl@ss 9.0	27440222

ETIM

ETIM 3.0	EC000438
ETIM 4.0	EC000438
ETIM 5.0	EC000438
ETIM 6.0	EC000438
ETIM 7.0	EC000438

Terminal adapter - HC-B 10-A-DT-PEL-M - 1648403

Classifications

UNSPSC

UNSPSC 6.01	30211923
UNSPSC 7.0901	39121522
UNSPSC 11	39121522
UNSPSC 12.01	39121522
UNSPSC 13.2	39121421
UNSPSC 18.0	39121522
UNSPSC 19.0	39121522
UNSPSC 20.0	39121522
UNSPSC 21.0	39121522

Approvals

Approvals

Approvals

CSA / UL Recognized / cUL Recognized / EAC / EAC / cULus Recognized

Ex Approvals

Approval details

CSA		http://www.csagroup.org/services-industries/product-listing/	013631_6233_01
Nominal voltage UN		600 V	
Nominal current IN		13 A	
mm ² /AWG/kcmil		22-14	

UL Recognized		http://database.ul.com/cgi-bin/XYV/template/LISEXT/1FRAME/index.htm	FILE E 118976
Nominal voltage UN		600 V	
Nominal current IN		13 A	
mm ² /AWG/kcmil		22-14	

Terminal adapter - HC-B 10-A-DT-PEL-M - 1648403

Approvals

cUL Recognized		http://database.ul.com/cgi-bin/XYVV/template/LISEXT/1FRAME/index.htm	FILE E 118976
Nominal voltage UN	600 V		
Nominal current IN	13 A		
mm ² /AWG/kcmil	22-14		

EAC		RU C- DE.AI30.B.01102
-----	--	--------------------------

EAC		RU C- DE.BL08.B.00511
-----	--	--------------------------

cULus Recognized	
------------------	--

Accessories

Accessories

Coding element

Coding profile - CP-HC - 1686478



Coding profile, 4 coding profiles per strip, for insertion in coding keyways

Coding element - HC-CST - 1676857



Coding peg for coding up to 16 connectors

Terminal adapter - HC-B 10-A-DT-PEL-M - 1648403

Accessories

Coding element - HC-CBU - 1676860



Coding socket for coding up to 16 connectors

Coding bolt - HC-CB - 1772722



Coding pin, prevents mismatching of up to six connectors with an identical number of positions

Labeled terminal marker

Zack marker strips off the roll, flat - ZBF-U CUS - 0828525



Zack marker strips off the roll, flat, can be ordered: Strip, white, labeled according to customer specifications, mounting type: snap into flat marker groove, for terminal block width: 1000 mm, lettering field size: 5.15 x ... mm

Mounting material

Foot element - HC-KA-FE - 1775240



Foot element, for mounting on DIN rail NS 32, DIN rail NS 35/7.5 or DIN rail NS 35/15, can be inserted between basic and side element

Locking screw barrel - HC-VSH - 1660083



Locking screw barrel, for a firm connection of contact inserts and DIN-rail mountable terminal adapters

Terminal adapter - HC-B 10-A-DT-PEL-M - 1648403

Accessories

Screw - HC-B-PES - 1604997



PE screw, for contact inserts HC-B / HC-BB / HC-DD / HC-D40 / HC-D64

PE multiplier - HC-B-3PE - 1644326



PE multiplier, for three PE connections, for HC-B (besides HC-B..E..ZZ) / HC-BB / HC-DD / HC-D40 / HC-D64 contact inserts

Screwdriver tools

Screwdriver - SZF 0-0,4X2,5 - 1204504



Actuation tool, for ST terminal blocks, also suitable for use as a bladed screwdriver, size: 0.4 x 2.5 x 75 mm, 2-component grip, with non-slip grip

Additional products

Contact insert - HC-B10-I-PT-F - 1407729



HEAVYCON socket insert, B10 series, 10 + PE-pos., push-in connection
