

## Contact insert - HC-A10-I-UT-M - 1585294

Please be informed that the data shown in this PDF Document is generated from our Online Catalog. Please find the complete data in the user's documentation. Our General Terms of Use for Downloads are valid (<http://phoenixcontact.com/download>)



HEAVYCON male insert, A10 series, 10-pos., screw connection

### Your advantages

- ✓ can be coded with plastic coding profile (order number 1410916)
- ✓ for a test pin 2 mm in diameter

COMPLETE RoHS

### Key Commercial Data

Packing unit	1 pc
GTIN	 4 046356 285025
GTIN	4046356285025
Weight per Piece (excluding packing)	40.000 g
Custom tariff number	85366990
Country of origin	China

### Technical data

#### General

Note	for flexible conductors with or without ferrules
	Connectors may be operated only when there is no load/voltage.
	for housing HC-D15
Connection method	Screw connection
Tightening torque	0.5 Nm
Torque	0.7 Nm ... 1 Nm (PE connection)
	0.5 Nm ... 0.8 Nm (Mounting screws for mounting in the HEAVYCON housing)

# Contact insert - HC-A10-I-UT-M - 1585294

## Technical data

### General

Screwdriver blade	0.5 x 3.5 mm
Number of connections per position	1
Degree of pollution	3
Overvoltage category	III
Number of positions	10+PE
Insertion/withdrawal cycles	≥ 500
Size	D15
Contact numbering	1 - 10
Conductor cross section	0.5 mm <sup>2</sup> ... 2.5 mm <sup>2</sup>
Connection cross section AWG	20 ... 14
Stripping length of the individual wire	7 mm
Assembly instructions	To ensure correct use, installation in housing with IP54 protection or better is required
Connection	for plastic coding profiles: 4 pcs.

### Ambient conditions

Ambient temperature (operation)	-40 °C ... 125 °C (including heating up of contacts)
---------------------------------	------------------------------------------------------

### Material data

Contact material	Copper alloy
Contact surface material	Ag
Contact carrier material	PC

### Electrical characteristics

Rated voltage (III/3)	250 V
Rated surge voltage	4 kV
Rated current	16 A

### Standards and Regulations

Flammability rating according to UL 94	V0
----------------------------------------	----

### Environmental Product Compliance

REACH SVHC	Lead 7439-92-1
China RoHS	Environmentally Friendly Use Period = 50 years
	For details about hazardous substances go to tab "Downloads", Category "Manufacturer's declaration"

## Drawings

# Contact insert - HC-A10-I-UT-M - 1585294

Diagram

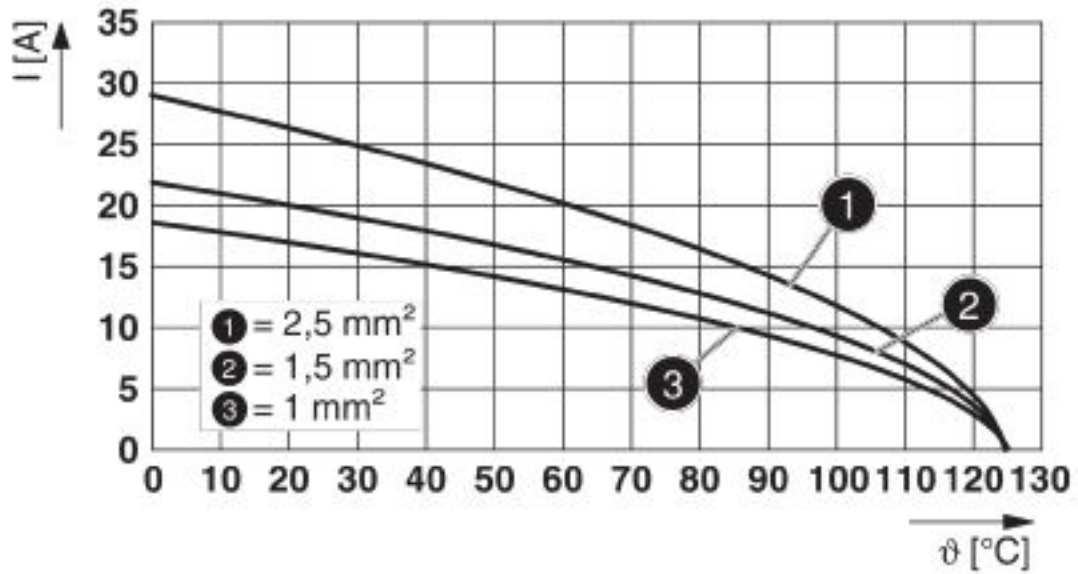

Derating diagram

Dimensional drawing

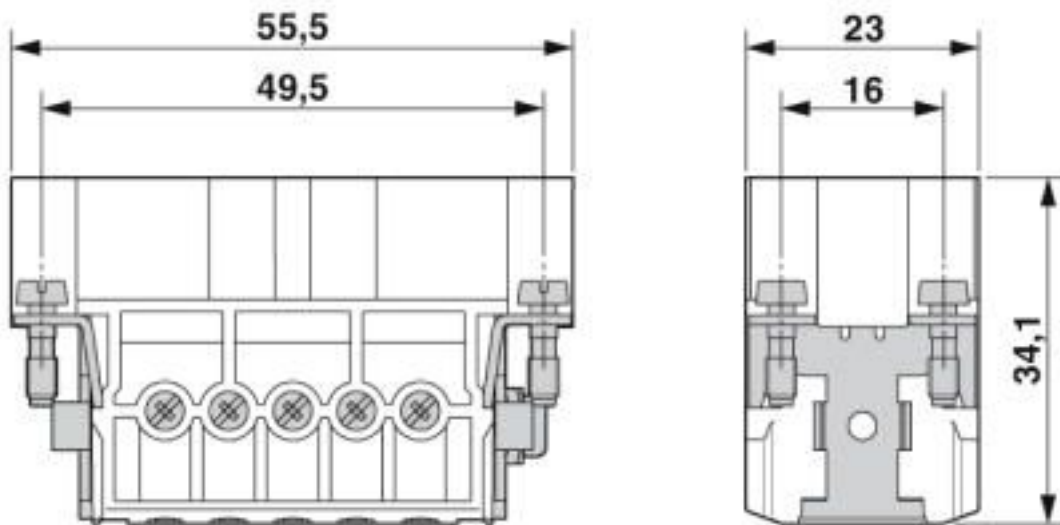

Male insert

# Contact insert - HC-A10-I-UT-M - 1585294

Dimensional drawing

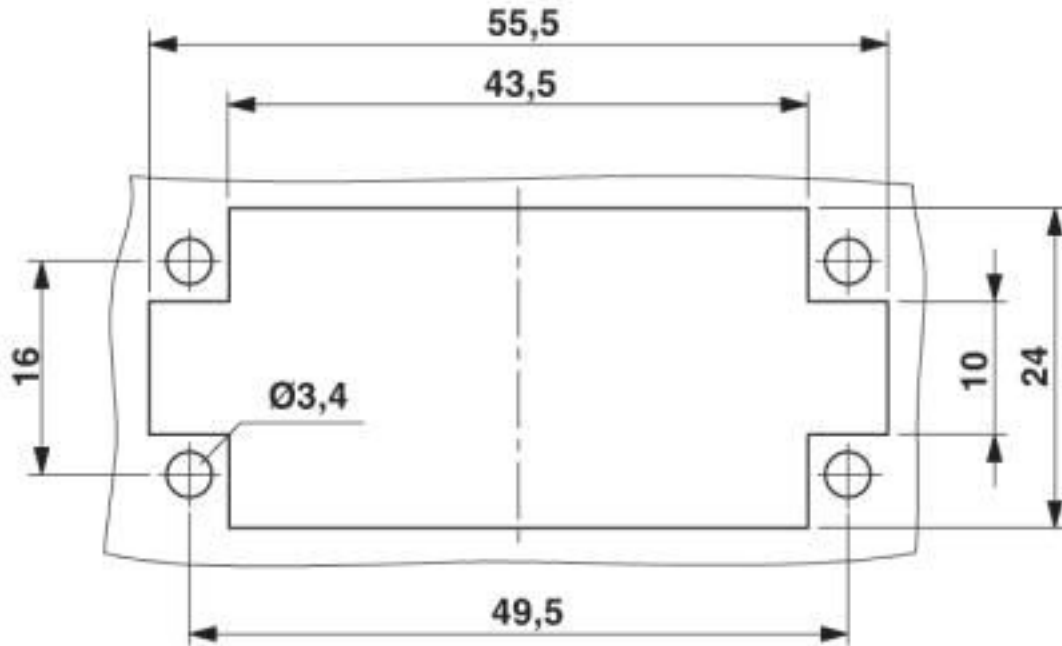

Mounting cutout when used without housing

# Contact insert - HC-A10-I-UT-M - 1585294

Schematic diagram

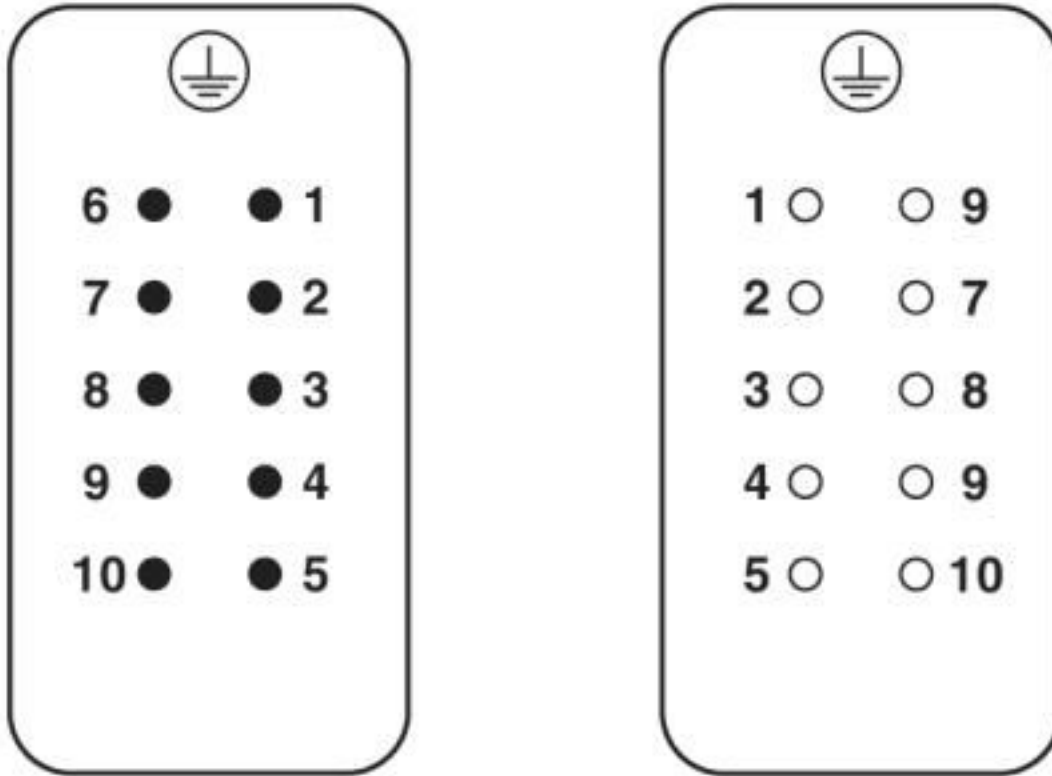

Pin assignment, connection side, pin left, socket right

## Classifications

eCl@ss

eCl@ss 10.0.1	27440205
eCl@ss 4.0	27140800
eCl@ss 4.1	27140800
eCl@ss 5.0	27143400
eCl@ss 5.1	27261200
eCl@ss 6.0	27261200
eCl@ss 7.0	27440205
eCl@ss 8.0	27440205
eCl@ss 9.0	27440205

ETIM

ETIM 4.0	EC000438
ETIM 5.0	EC000438

# Contact insert - HC-A10-I-UT-M - 1585294

## Classifications

### ETIM

ETIM 6.0	EC000438
ETIM 7.0	EC000438

### UNSPSC

UNSPSC 6.01	30211923
UNSPSC 7.0901	39121522
UNSPSC 11	39121522
UNSPSC 12.01	39121522
UNSPSC 13.2	39121522
UNSPSC 18.0	39121522
UNSPSC 19.0	39121522
UNSPSC 20.0	39121522
UNSPSC 21.0	39121522

## Approvals

### Approvals

#### Approvals

CSA / EAC / EAC / CSA / EAC / EAC / UL Recognized / UL Recognized / DNV GL / DNV GL

#### Ex Approvals

### Approval details

CSA		<a href="http://www.csagroup.org/services-industries/product-listing/">http://www.csagroup.org/services-industries/product-listing/</a>	13631
-----	--	-----------------------------------------------------------------------------------------------------------------------------------------	-------

EAC			RU C- DE.AI30.B.01102
-----	--	--	--------------------------

EAC			RU C- DE.AI30.B.01102
-----	--	--	--------------------------

# Contact insert - HC-A10-I-UT-M - 1585294

## Approvals

CSA		<a href="http://www.csagroup.org/services-industries/product-listing/">http://www.csagroup.org/services-industries/product-listing/</a>	13631
Nominal voltage UN		600 V	
Nominal current IN		15 A	
mm <sup>2</sup> /AWG/kcmil		14	

EAC			RU C- DE.BL08.B.00511
-----	-----------------------------------------------------------------------------------	--	--------------------------

EAC			RU C- DE.BL08.B.00511
-----	-----------------------------------------------------------------------------------	--	--------------------------

UL Recognized		<a href="http://database.ul.com/cgi-bin/XYV/template/LISEXT/1FRAME/index.htm">http://database.ul.com/cgi-bin/XYV/template/LISEXT/1FRAME/index.htm</a>	E118976
---------------	-------------------------------------------------------------------------------------	-------------------------------------------------------------------------------------------------------------------------------------------------------	---------

UL Recognized		<a href="http://database.ul.com/cgi-bin/XYV/template/LISEXT/1FRAME/index.htm">http://database.ul.com/cgi-bin/XYV/template/LISEXT/1FRAME/index.htm</a>	E118976
Nominal voltage UN		600 V	
Nominal current IN		19 A	
mm <sup>2</sup> /AWG/kcmil		14	

DNV GL		<a href="https://approvalfinder.dnvgl.com/">https://approvalfinder.dnvgl.com/</a>	TAE000037S
--------	-------------------------------------------------------------------------------------	-----------------------------------------------------------------------------------	------------

DNV GL		<a href="https://approvalfinder.dnvgl.com/">https://approvalfinder.dnvgl.com/</a>	TAE000037S
--------	-------------------------------------------------------------------------------------	-----------------------------------------------------------------------------------	------------

## Accessories

### Accessories

## Contact insert - HC-A10-I-UT-M - 1585294

### Accessories

#### Coding element

Coding element - HC-CST - 1676857



Coding peg for coding up to 16 connectors

---

Coding element - HC-CBU - 1676860



Coding socket for coding up to 16 connectors

---

Coding bolt - HC-CB - 1772722



Coding pin, prevents mismatching of up to six connectors with an identical number of positions

---

Coding profile - CP-HC-S - 1410916



Coding profile, 4 elements per star, for insertion in a coding keyway, for contact inserts HC-BB... / HC-A10-I-UT... / HC-A16-I-UT...

---

#### Mounting material

Screw - HC-A-PES - 1584868



PE screw for contact inserts of A series



## Contact insert - HC-A10-I-UT-M - 1585294

### Accessories

---

#### Additional products

Contact insert - HC-A10-I-UT-F - 1585304



HEAVYCON female insert, A10 series, 10-pos., screw connection

---

---