

Contact insert - HC-Q12-I-CT-M - 1418626

Please be informed that the data shown in this PDF Document is generated from our Online Catalog. Please find the complete data in the user's documentation. Our General Terms of Use for Downloads are valid (<http://phoenixcontact.com/download>)



Contact insert, number of positions: 12+PE, size: D7, number of connections per position: 1, Pin, Crimp connection, 400 V, 12 A, 0.14 mm² ... 2.5 mm²

Your advantages

- ✓ Can be keyed in seconds thanks to plastic profiles
- ✓ 16 coding options without loss of contact space.
- ✓ For all D7 housing designs
- ✓ Cost-effective and saves space thanks to high number of contacts within a small surface area
- ✓ Contact insert including IP65 sealing screw



Key Commercial Data

Packing unit	1 pc
GTIN	 4 055626 249391
GTIN	4055626249391
Weight per Piece (excluding packing)	20.000 g
Custom tariff number	85389099
Country of origin	China

Technical data

General

Note	For HC-D7 housing, crimp contacts CK1,6-ED (crimp contacts not included in scope of supply)
	Connectors may be operated only when there is no load/voltage.
Connection method	Crimp connection
	PE connection

Contact insert - HC-Q12-I-CT-M - 1418626

Technical data

General

Number of connections per position	1
Degree of pollution	3
Overvoltage category	III
Number of positions	12+PE
Insertion/withdrawal cycles	≥ 500
Size	D7
Contact numbering	1 - 12
Conductor cross section	0.14 mm ² ... 2.5 mm ²
Connection cross section AWG	26 ... 14
Stripping length of the individual wire	8 mm
	6 mm (2.5 mm ²)
Assembly instructions	To ensure correct use, installation in housing with IP54 protection or better is required
Connection	Contact insert including IP67 sealing screw.

Ambient conditions

Ambient temperature (operation)	-40 °C ... 125 °C (including heating up of contacts)
---------------------------------	--

Material data

Seal material	NBR, conductive
Contact material	Copper alloy
Contact surface material	Ag (alternatively Au)
Contact carrier material	PC

Electrical characteristics

Rated voltage (III/3)	400 V
Rated surge voltage	6 kV
Rated current	12 A

Standards and Regulations

Flammability rating according to UL 94	V0
--	----

Environmental Product Compliance

REACH SVHC	Lead 7439-92-1
China RoHS	Environmentally Friendly Use Period = 50 years
	For details about hazardous substances go to tab "Downloads", Category "Manufacturer's declaration"

Drawings

Contact insert - HC-Q12-I-CT-M - 1418626

Diagram

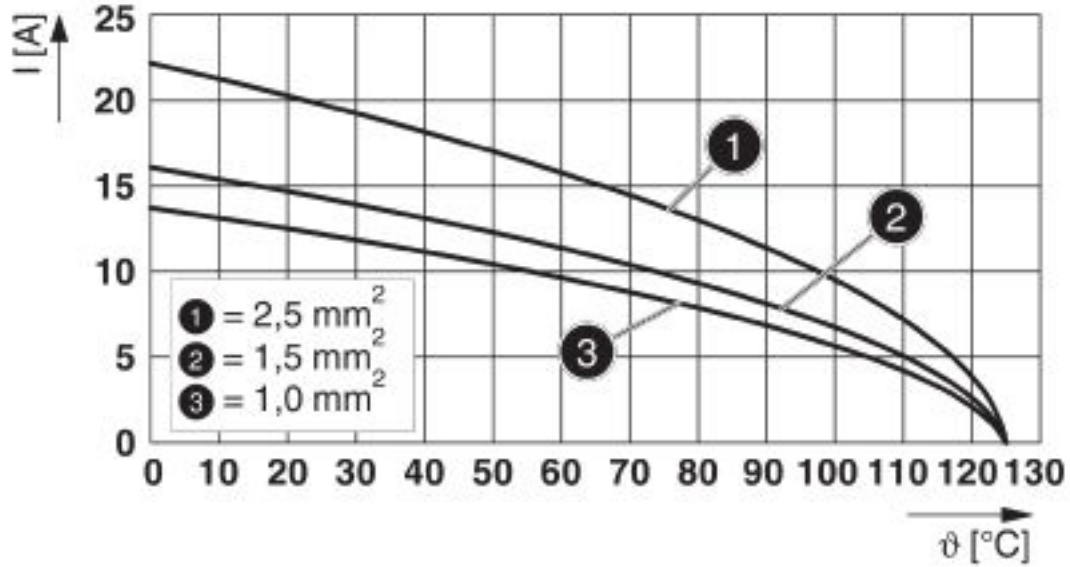

Derating diagram turned contacts

Diagram

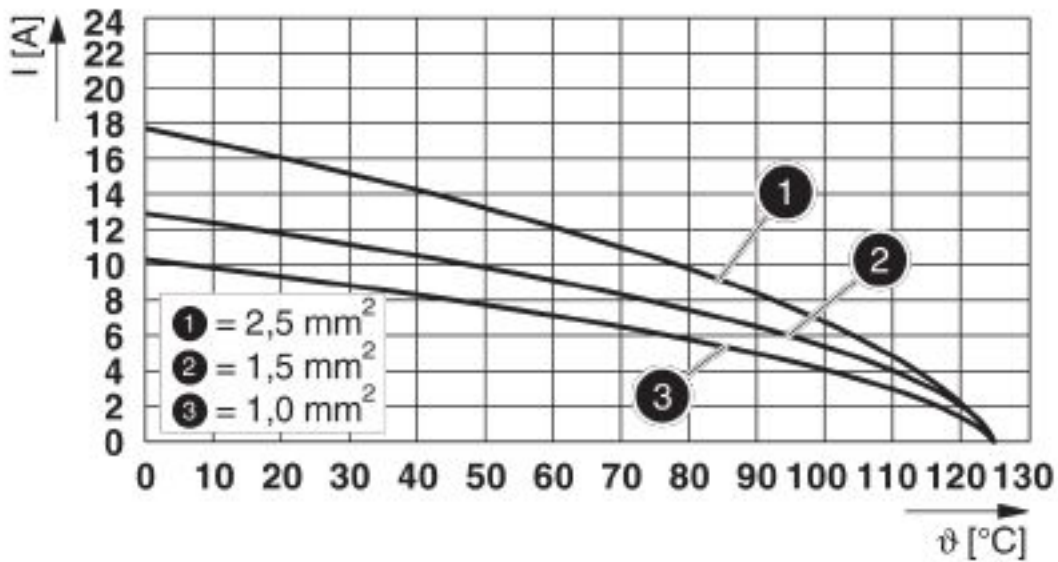

Derating diagram rolled contacts

Contact insert - HC-Q12-I-CT-M - 1418626

Dimensional drawing

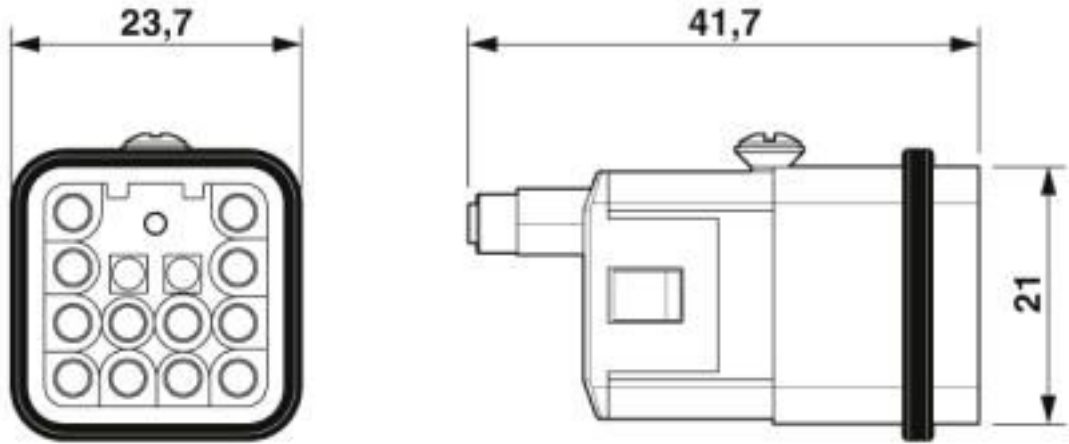

Dimensional drawing: HC-Q 12-I-CT-M

Contact insert - HC-Q12-I-CT-M - 1418626

Schematic diagram

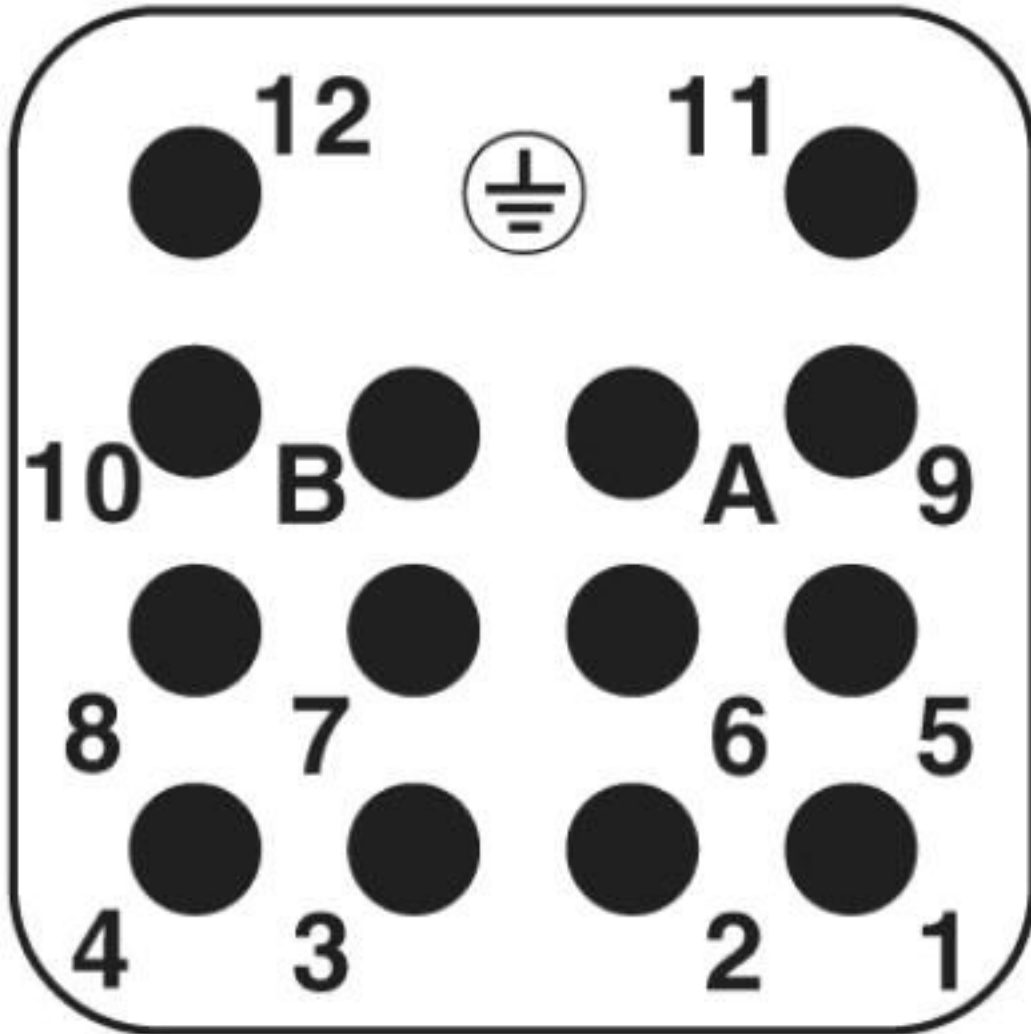

Pin assignment connection side. Position A and B for coding profiles

Contact insert - HC-Q12-I-CT-M - 1418626

Schematic diagram

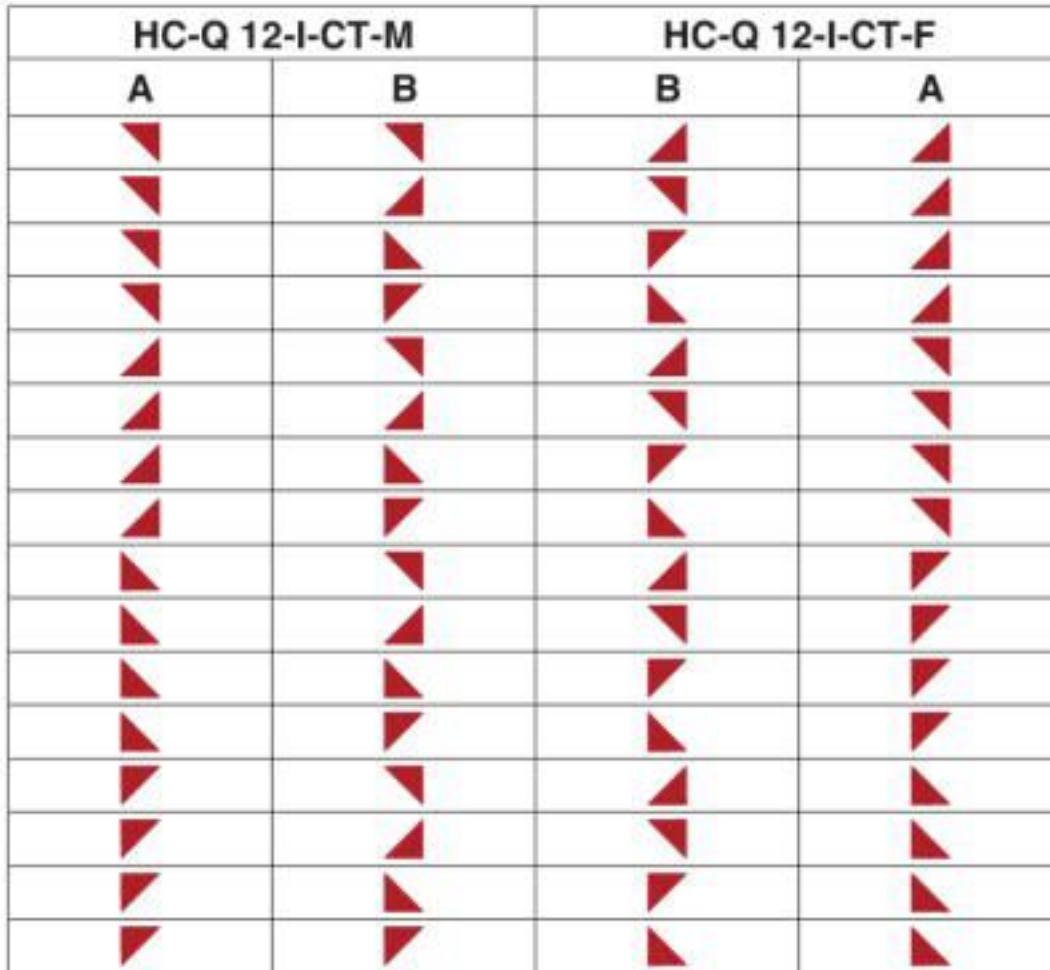

Coding scheme

Classifications

eCl@ss

eCl@ss 10.0.1	27440205
eCl@ss 5.1	27261200
eCl@ss 6.0	27261200
eCl@ss 7.0	27440205
eCl@ss 8.0	27440205
eCl@ss 9.0	27440205

Contact insert - HC-Q12-I-CT-M - 1418626

Classifications

ETIM

ETIM 5.0	EC000438
ETIM 6.0	EC000438
ETIM 7.0	EC000438

UNSPSC

UNSPSC 13.2	39121522
UNSPSC 18.0	39121522
UNSPSC 19.0	39121522
UNSPSC 20.0	39121522
UNSPSC 21.0	39121522

Approvals

Approvals

Approvals

CSA / UL Recognized / EAC / DNV GL / EAC

Ex Approvals

Approval details

CSA		http://www.csagroup.org/services-industries/product-listing/	13631
Nominal voltage UN	600 V		
Nominal current IN	12 A		
mm ² /AWG/kcmil	14		

UL Recognized		http://database.ul.com/cgi-bin/XYV/template/LISEXT/1FRAME/index.htm	E118976
Nominal voltage UN	600 V		
Nominal current IN	15 A		

Contact insert - HC-Q12-I-CT-M - 1418626

Approvals

mm ² /AWG/kcmil	14
----------------------------	----

EAC		RU C- DE.AI30.B.01102
-----	--	--------------------------

DNV GL		https://approvalfinder.dnvgl.com/	TAE000037S
--------	--	---	------------

EAC		RU C- DE.BL08.B.00511
-----	--	--------------------------

Accessories

Accessories

Assembly tool

Contact removal tool - VC-EW 1,6 - 1884869



Contact removal tool, for turned and rolled CK- 1.6-... contacts

Coding element

Coding element - HC-Q 12-COD - 1409435



Coding profile for Q12 series

Crimp contact

Contact insert - HC-Q12-I-CT-M - 1418626

Accessories

Crimp contact - CK1,6-ED-0,37ST AG - 1663336



Turned 1.6 crimp contact, individual male contact, core diameter 0.14 to 0.37 mm², silver-plated

Crimp contact - CK1,6-ED-0,50ST AG - 1663349



Turned 1.6 crimp contact, individual male contact, core diameter 0.5 mm², silver-plated

Crimp contact - CK1,6-ED-0,75ST AG - 1663352



Turned 1.6 crimp contact, individual male contact, core diameter 0.75 mm², silver-plated

Crimp contact - CK1,6-ED-1,00ST AG - 1663365



Turned 1.6 crimp contact, individual male contact, core diameter 0.75 to 1.00 mm², silver-plated

Crimp contact - CK1,6-ED-1,50ST AG - 1663378



Turned 1.6 crimp contact, individual male contact, core diameter 1.5 mm², silver-plated

Contact insert - HC-Q12-I-CT-M - 1418626

Accessories

Crimp contact - CK1,6-ED-2,50ST AG - 1663381



Turned 1.6 crimp contact, individual male contact, core diameter 2.5 mm², silver-plated

Crimp contact - CK1,6-ED-0,37ST AU - 1674901



Turned 1.6 crimp contact, individual male contact, core diameter 0.14 to 0.37 mm², gold-plated

Crimp contact - CK1,6-ED-0,50ST AU - 1672453



Turned 1.6 crimp contact, individual male contact, core diameter 0.5 mm², gold-plated

Crimp contact - CK1,6-ED-0,75ST AU - 1674914



Turned 1.6 crimp contact, individual male contact, core diameter 0.75 mm², gold-plated

Crimp contact - CK1,6-ED-1,00ST AU - 1674888



Turned 1.6 crimp contact, individual male contact, core diameter 0.75 to 1.00 mm², gold-plated

Contact insert - HC-Q12-I-CT-M - 1418626

Accessories

Crimp contact - CK1,6-ED-1,50ST AU - 1674875



Turned 1.6 crimp contact, individual male contact, core diameter 1.5 mm², gold-plated

Crimp contact - CK1,6-ED-2,50ST AU - 1674927



Turned 1.6 crimp contact, individual male contact, core diameter 2.5 mm², gold-plated

Crimping tool

Crimping pliers - CRIMPFOX-TC 4 - 1212113



Crimping pliers, for CK 1,6-ED..., CK 2,5-ED..., CK 4,0-ED... turned contacts, 4 marked die stations, unlockable pressure lock, lateral entry, incl. positioning tool

Fiber optics contact

Male contact - CK1,6-ED-ST-POF - 1884995



POF fiber optic pin contact, turned, for contact carriers (HC-DD...I-CT.../ HC-M-12-CT-.../ HC-M-17-CT-...) of CK1,6-ED... contacts

Mounting material

Contact insert - HC-Q12-I-CT-M - 1418626

Accessories

Sealing screw - HC-D 7-DS-IP65 - 1686229



Sealing screw, size: Countersunk head, IP67, replacement part for D7 size HEAVYCON housing

Seal

Profile gasket - HC-D07-SP-RBK - 1419622



Profile gasket, type: D7, for pin inserts

Additional products

Contact insert - HC-Q12-I-CT-F - 1418625



Contact insert, number of positions: 12+PE, size: D7, number of connections per position: 1, Socket, Crimp connection, 400 V, 12 A, 0.14 mm² ... 2.5 mm²

Spare parts

Sealing screw - HC-D 7-DS-IP65 - 1686229



Sealing screw, size: Countersunk head, IP67, replacement part for D7 size HEAVYCON housing
