

Module plate - MD-INB24-4-SZP-S - 1415243

Please be informed that the data shown in this PDF Document is generated from our Online Catalog. Please find the complete data in the user's documentation. Our General Terms of Use for Downloads are valid (<http://phoenixcontact.com/download>)

Module plate, with seal, for CES B24 sealing frames, with 4 openings, including mounting screws



Product Description

Module plate
8 mounting screws (M5x12) /
and
Washers are supplied as standard

Key Commercial Data

Packing unit	1 pc
GTIN	
GTIN	4055626039480
Weight per Piece (excluding packing)	720.000 g
Custom tariff number	73089059
Country of origin	Germany

Technical data

Dimensions

Length	338 mm
Width	168 mm
Height	2 mm

Ambient conditions

Degree of protection	IP54
Ambient temperature (operation)	-40 °C ... 100 °C

Module plate - MD-INB24-4-SZP-S - 1415243

Technical data

General

Product description	Module plate 8 mounting screws (M5x12) / and Washers are supplied as standard
Material	Stainless steel 1.4301/AISI 304
	NBR (Seal)
Color	silver grey
Seal present	yes
Torque	1 Nm ... 1.2 Nm (Mounting screw, M5)
Note	incl. mounting screws
Installation instructions	Diameter of fixing hole for self-tapping screw: 4.5 mm ... 4.7 mm, mounting screws (M5x12): 1.0 Nm ... 1.2 Nm tightening torque, SW4 Allen key
	Make sure the seal is fitted correctly (must not be squeezed out at the sides)

Environmental Product Compliance

China RoHS	Environmentally friendly use period: unlimited = EFUP-e
	No hazardous substances above threshold values

Drawings

Module plate - MD-INB24-4-SZP-S - 1415243

Dimensional drawing

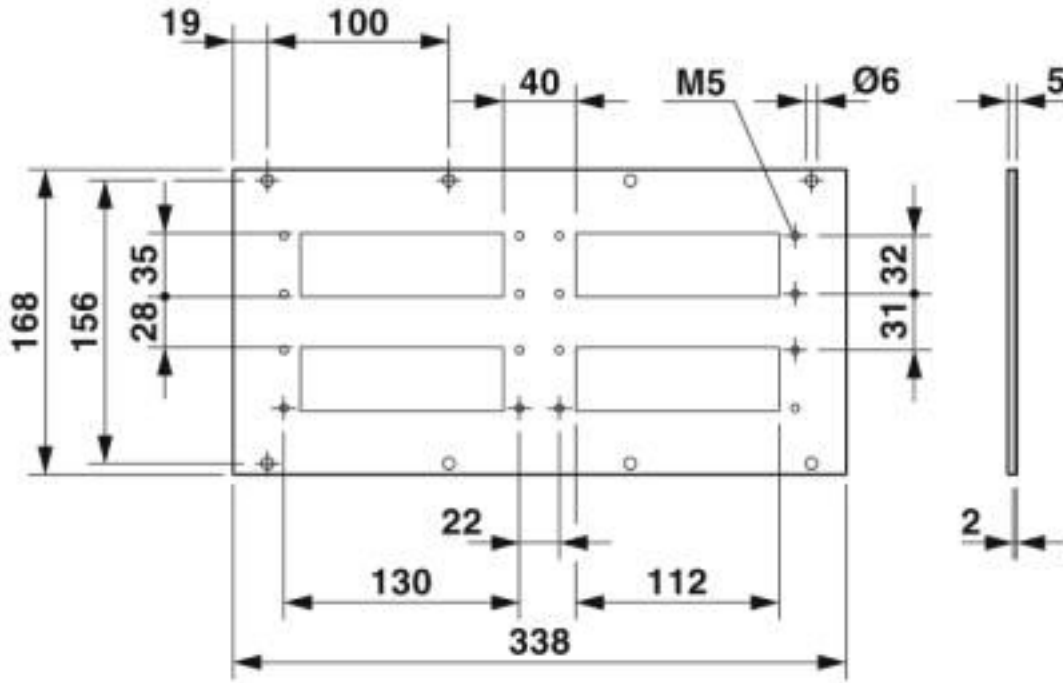

Module plate - MD-INB24-4-SZP-S - 1415243

Dimensional drawing

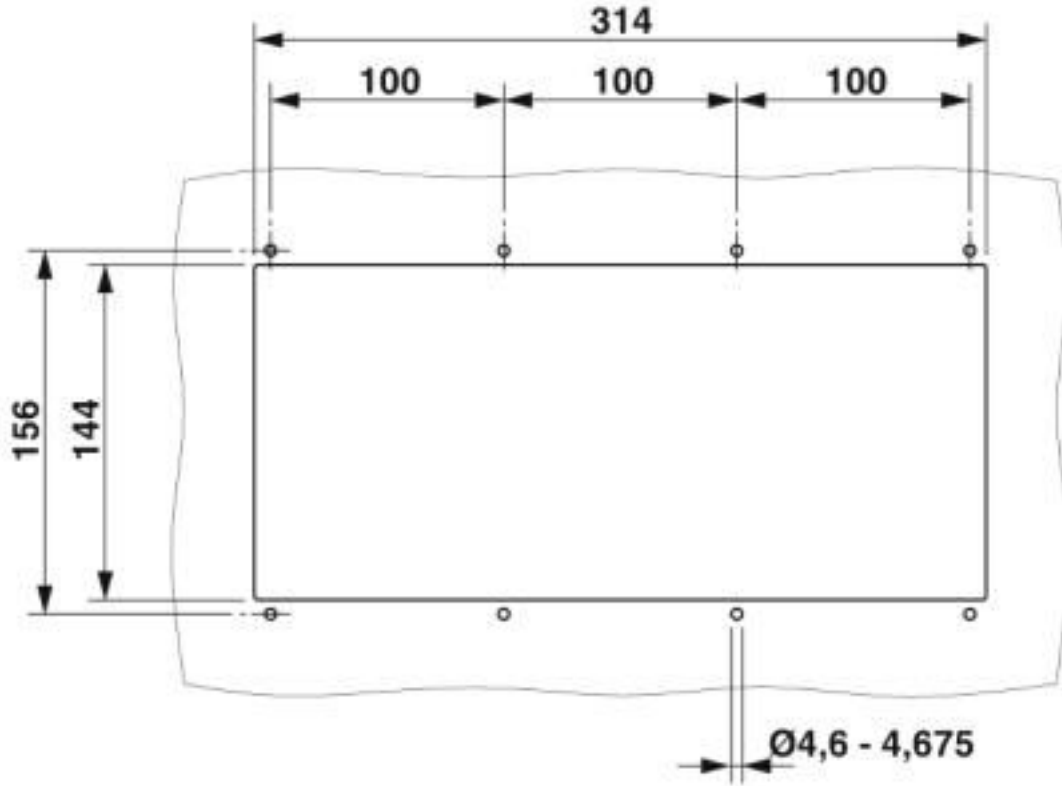

Wall cutout drawing

Classifications

eCl@ss

eCl@ss 10.0.1	27440201
eCl@ss 4.0	27081000
eCl@ss 4.1	27081000
eCl@ss 5.0	27081000
eCl@ss 5.1	27081000
eCl@ss 6.0	27261200
eCl@ss 7.0	27440201
eCl@ss 8.0	27440201
eCl@ss 9.0	27440201

ETIM

ETIM 5.0	EC002309
ETIM 6.0	EC002309

Module plate - MD-INB24-4-SZP-S - 1415243

Classifications

ETIM

ETIM 7.0	EC002309
----------	----------

UNSPSC

UNSPSC 13.2	31261501
UNSPSC 18.0	31261501
UNSPSC 19.0	31261501
UNSPSC 20.0	31261501
UNSPSC 21.0	31261501