

Cable gland - G-INESR-M40-M68N-NEPDS-S - 1415195

Please be informed that the data shown in this PDF Document is generated from our Online Catalog. Please find the complete data in the user's documentation. Our General Terms of Use for Downloads are valid (<http://phoenixcontact.com/download>)



Cable gland, cable gland material: Nickel-plated brass, external cable diameter 16 mm ... 28 mm, shielding: no, connecting thread: M40 x 1.5, color: silver, with external strain relief, with O-ring

Your advantages

- Weatherproof sealing material
- Halogen-free

Key Commercial Data

Packing unit	1 pc
GTIN	 4 055626 038681
GTIN	4055626038681
Weight per Piece (excluding packing)	360.000 g
Custom tariff number	74199990
Country of origin	Germany

Technical data

Dimensions

Length	54 mm
Length without connecting thread	46 mm
Wrench size, union nut	46 mm
Wrench size, support	46 mm
Hexagon angular dimension	51 mm
Length of the connecting thread	8 mm
Feed-through hole diameter	40.1 mm ... 40.3 mm
External cable diameter	16 mm ... 28 mm

Cable gland - G-INESR-M40-M68N-NEPDS-S - 1415195

Technical data

Dimensions

	17.4 mm ... 26.4 mm (for UL 514 B)
Clamping range of the strain relief clip	16.00 mm ... 28.00 mm

Ambient conditions

Degree of protection (IP)	IP68 (5 bar / 0.5 h)
	IP69 (DIN EN 60529 / IEC 60529)
Ambient temperature (operation)	-40 °C ... 100 °C (static)

General

Type	with external strain relief
No. of conductors	1
Cable gland material	Nickel-plated brass
Material, insert	PA
Cable seal material	EPDM
O-ring material	EPDM
Shielded	no
Thread type on connection side	M40 x 1.5
Torque	20 Nm (Union nut: EN 62444)
	20 Nm (Support: EN 62444)
	0.5 Nm (Screw for clip)
Color	silver
Impact category	6
Execution of the strain relief	B
Manufacturer	WISKA
Manufacturer Designation	EMSKVZ 40

Standards and Regulations

Halogen-free	yes
--------------	-----

Environmental Product Compliance

REACH SVHC	Lead 7439-92-1
China RoHS	Environmentally Friendly Use Period = 50 years
	For details about hazardous substances go to tab "Downloads", Category "Manufacturer's declaration"

Drawings

Cable gland - G-INESR-M40-M68N-NEPDS-S - 1415195

Dimensional drawing

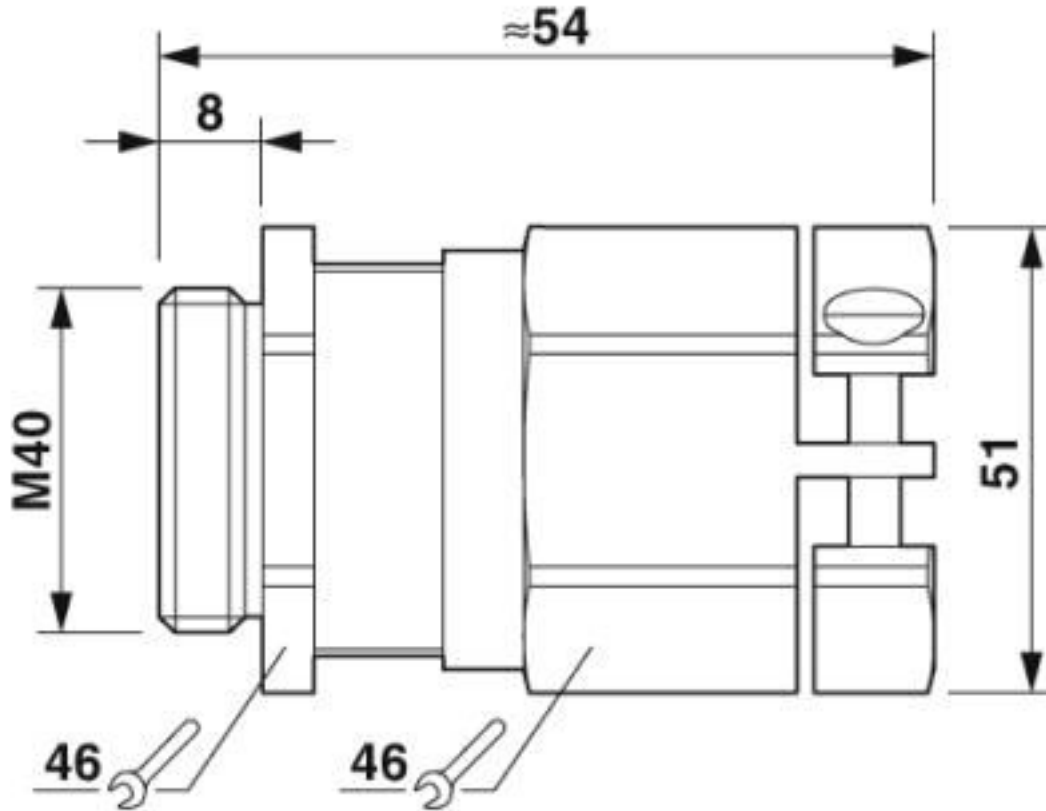

Classifications

eCl@ss

eCl@ss 10.0.1	27144432
eCl@ss 4.0	27141200
eCl@ss 4.1	27141200
eCl@ss 5.0	27149100
eCl@ss 5.1	27149100
eCl@ss 6.0	27149100
eCl@ss 7.0	27149109
eCl@ss 8.0	27149109
eCl@ss 9.0	27144432

ETIM

ETIM 5.0	EC000441
ETIM 6.0	EC000441

Cable gland - G-INESR-M40-M68N-NEPDS-S - 1415195

Classifications

ETIM

ETIM 7.0	EC000441
----------	----------

UNSPSC

UNSPSC 13.2	39121311
UNSPSC 18.0	39121311
UNSPSC 19.0	39121311
UNSPSC 20.0	39121311
UNSPSC 21.0	39121311

Approvals

Approvals

Approvals

UL Recognized / cUL Recognized / GOST-R / cULus Recognized

Ex Approvals

Approval details

UL Recognized		http://database.ul.com/cgi-bin/XYV/template/LISEXT/1FRAME/index.htm	E179850
---------------	--	---	---------

cUL Recognized		http://database.ul.com/cgi-bin/XYV/template/LISEXT/1FRAME/index.htm	E179850
----------------	--	---	---------

GOST-R			POCC DE.A*98.H12052
--------	--	--	------------------------

cULus Recognized			
------------------	--	--	--

Cable gland - G-INESR-M40-M68N-NEPDS-S - 1415195

Accessories

Accessories

Flat nut

Counter nut - A-INL-M40-N-S - 1411246



Counter nut, material: Brass, nickel-plated, for threads M40 x 1.5, color: silver