

Housing - HC-ADV-B10-HHWH-1STM25-EMC-AL - 1413401

Please be informed that the data shown in this PDF Document is generated from our Online Catalog. Please find the complete data in the user's documentation. Our General Terms of Use for Downloads are valid (<http://phoenixcontact.com/download>)



HEAVYCON ADVANCE sleeve housing, B10, with stainless steel screw locking (Allen screw), salt-water-resistant aluminum, height 93.7 mm, with 1x M25 thread, lateral cable outlet, without surface; conductive seal (EMC properties)



Key Commercial Data

Packing unit	1 pc
GTIN	 4 055626 030357
GTIN	4055626030357
Weight per Piece (excluding packing)	260.000 g
Custom tariff number	85389099
Country of origin	China

Technical data

Dimensions

Height	93.7 mm
Width	57 mm
Length	105 mm
Length of the assembly cutout	65 mm
Width of the assembly cutout	35 mm

Ambient conditions

Degree of protection of housing (IP)	IP66
	IP68 (0.2 bar/24 h)
	IP69 (ISO 20653:2013-02)
Degree of protection of housing (NEMA)	4 (UL 50e)
	4X (UL 50e)

Housing - HC-ADV-B10-HHWH-1STM25-EMC-AL - 1413401

Technical data

Ambient conditions

	12 (UL 50e)
Ambient temperature (operation)	-40 °C ... 125 °C

General

Note	For contact inserts HC-B10, BB18, DD42, M, K8/24
Size	B10
Housing type	Sleeve housing
Color	gray aluminum
Locking type	with screw locking
Fixing screws	M6 (screw head: 5 mm Allen screw)
No. of cable outlets	1
Cable outlet	lateral
Screw connection	none
Type of the screw connection	1x M25
Housing material	Die-cast aluminum, salt water resistant
Housing surface material	uncoated
Seal material	NBR, conductive
Material lock	Stainless steel
Assembly instructions	In order to guarantee that the ground conductor contact functions even when plugged in at an angle, the two panel mounting flanges must have sufficient electrical contact with the metal mounting panel.
Connection	To ensure optimum shielding, any insulating power coating must be removed from the profile gasket area on the control cabinet panel. Tightening torque of locking screw: 3 Nm.

Environmental Product Compliance

China RoHS	Environmentally Friendly Use Period = 50 years
	For details about hazardous substances go to tab "Downloads", Category "Manufacturer's declaration"

Drawings

Housing - HC-ADV-B10-HHWH-1STM25-EMC-AL - 1413401

Dimensional drawing

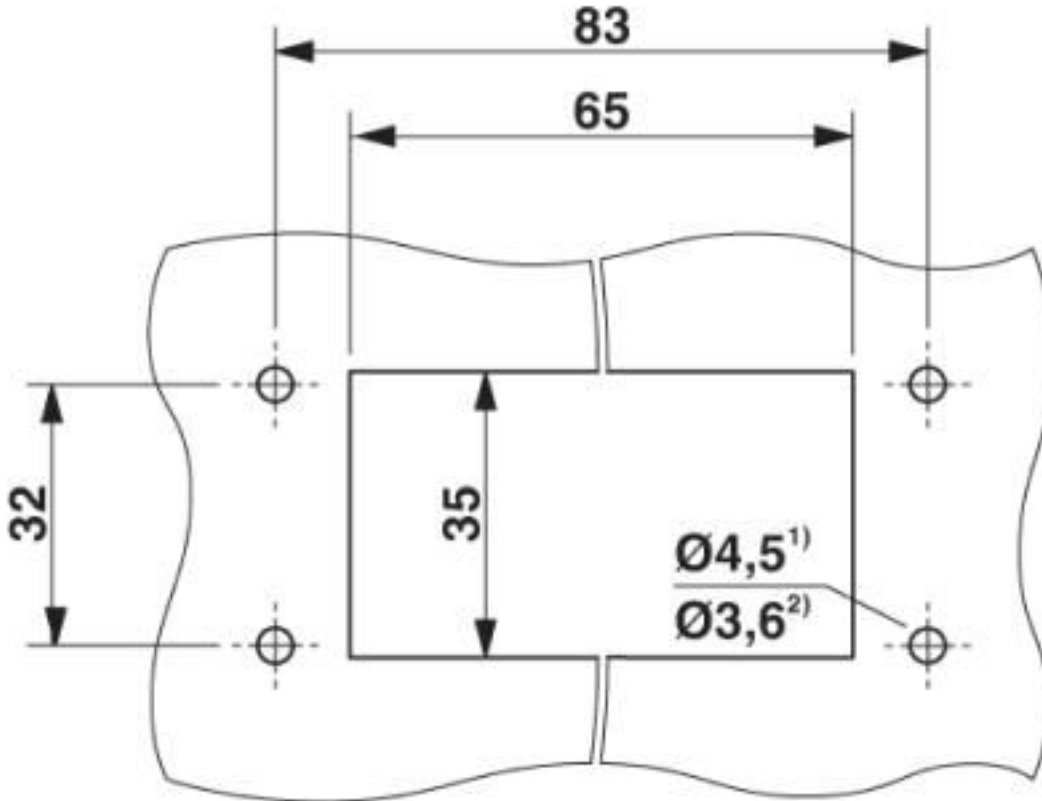

Mounting cutout

1) when M4 screws are used

2) when self-tapping Torx® screws are used (Torx® 20, M4)

Housing - HC-ADV-B10-HHWH-1STM25-EMC-AL - 1413401

Dimensional drawing

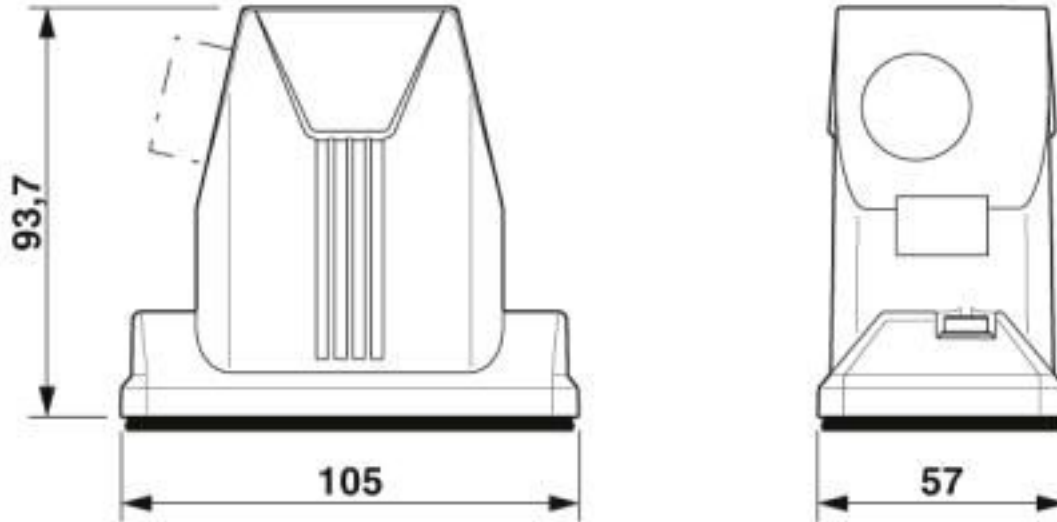

Dimensional drawing

Classifications

ETIM

ETIM 5.0	EC000437
ETIM 6.0	EC000437
ETIM 7.0	EC000437

UNSPSC

UNSPSC 13.2	31261501
UNSPSC 18.0	31261501
UNSPSC 19.0	31261501
UNSPSC 20.0	31261501
UNSPSC 21.0	31261501

eCl@ss

eCl@ss 10.0.1	27440202
eCl@ss 5.1	27261200
eCl@ss 6.0	27261200
eCl@ss 7.0	27440202
eCl@ss 8.0	27440202
eCl@ss 9.0	27440202

Housing - HC-ADV-B10-HHWH-1STM25-EMC-AL - 1413401

Approvals





Approvals

Approvals

UL Recognized / cUL Recognized / EAC / DNV GL / cULus Recognized

Ex Approvals

Approval details

UL Recognized		http://database.ul.com/cgi-bin/XYV/template/LISEXT/1FRAME/index.htm	E255026
cUL Recognized		http://database.ul.com/cgi-bin/XYV/template/LISEXT/1FRAME/index.htm	E255026
EAC			RU C- DE.AI30.B.01102
DNV GL		https://approvalfinder.dnvgl.com/	TAE000037S
cULus Recognized			

Accessories

Accessories

Full screw connection

Housing - HC-ADV-B10-HHWH-1STM25-EMC-AL - 1413401

Accessories

Cable gland - HC-K-KV-M25(11-17) - 1690639



Plastic screw connection up to 5 bar, thread length: 8 mm, cable diameter: 11 - 17 mm, WAF 29, screw connection: M25

Cable gland - HC-M-KV-M25(14-21) - 1646007



Metal screw connection up to 5 bar, thread length: 7 mm, cable diameter: 14 - 21 mm, WAF 34, screw connection: M25

Cable gland - HC-EMV-KV-M25(9-16,5) - 1690516



EMC screw connection up to 5 bar, thread length: 7.5 mm, cable diameter: 9.0 - 16.5 mm, WAF 29, screw connection: M25

Cable gland - HC-M-KV-M25(1ASI) - 1584020



Metal screw connection for an AS-Interface flat-ribbon conductor, thread type M25

Labeled device marker

Plastic label - US-EMLP (20X9) CUS - 0830085



Plastic label, can be ordered: By card, white, labeled according to customer specifications, mounting type: adhesive, lettering field size: 20 x 9 mm, Number of individual labels: 75

Housing - HC-ADV-B10-HHWH-1STM25-EMC-AL - 1413401

Accessories

Multiple screw connection

Cable gland - HC-M-KV-M25(1X10/1X11) - 1580228



Special cable screw connection M25, brass nickel-plated, grommet with 10 mm and 11 mm holes

Panel mounting flange

Mounting flange - HC-B-AF - 1686533



Panel mounting flange for HEAVYCON-ADVANCE TMS housing with screw locking

Mounting flange - HC-B-AF-SET - 1604638



Panel mounting flange for screw locking, set comprising 2 panel mounting flanges with 4 self-tapping screws (M4, Torx®) and 4 fan-type washers

Protective cover

Protective covers - HC-B 10-TMS-SD-IP50 - 1690749



Protective cover B10, Clip locking, protective cover material: PA, height: 31.2 mm, seal: no, With lanyard, diameter of retaining cord eyelet: 4 mm

Housing - HC-ADV-B10-HHWH-1STM25-EMC-AL - 1413401

Accessories

Protective covers - HC-B 10-TMS-SD-IP65 - 1690781



HEAVYCON ADVANCE IP65 protective cover B10, for panel mounting side, with screw locking, with retaining cord, diameter of retaining cord eyelet 3 mm

Screwdriver tools

Screwdriver - SF-BIT-HEXB 5-89 - 1208911



Screw bit, hexagonal with ball head, E6.3-1/4" drive, size: Hex 5 x 89 mm, hardened, suitable for holder according to DIN 3126-F 6.3/ISO 1173

Screwdriver - SF-M BH - 1212070



Bit screwdriver, with 1/4" quick-action chuck, handle length 119 mm, 2-component handle, with non-slip grip, suitable for bits according to DIN 3126-C 6.3 and E 6.3/ISO 1173, magnetic