

## Housing - HC-STA-B24-CHWS-1TTP21-ELC-AL - 1412748

Please be informed that the data shown in this PDF Document is generated from our Online Catalog. Please find the complete data in the user's documentation. Our General Terms of Use for Downloads are valid (<http://phoenixcontact.com/download>)



Coupling housings B24, with single locking latch, material: Die-cast aluminum, salt water resistant, cable outlets: 1, straight, height: 77 mm, cable gland: none, support sleeve: no, 1x Pg21, Standard

### Your advantages

- good shielding in the event of electromagnetic interference



### Key Commercial Data

Packing unit	1 pc
GTIN	 4 055626 059006
GTIN	4055626059006
Weight per Piece (excluding packing)	320.000 g
Custom tariff number	85389099
Country of origin	China

### Technical data

#### Dimensions

Height	77 mm
Width	44 mm
Length	120 mm

#### Ambient conditions

Degree of protection (IP)	IP66
	IP67
Degree of protection (NEMA)	4 (UL 50e)
	4X (UL 50e)

# Housing - HC-STA-B24-CHWS-1TTP21-ELC-AL - 1412748

## Technical data

### Ambient conditions

	12 (UL 50e)
Ambient temperature (operation)	-40 °C ... 125 °C

### General

Note	for contact inserts HC-B24, BB46, D64, DD108, HV10/16, M
Size	B24
Housing type	Coupling housings
Color	gray aluminum
Locking type	with single locking latch
No. of cable outlets	1
Cable outlet	straight
Screw connection	none
Type of the screw connection	1x Pg21
Housing material	Die-cast aluminum, salt water resistant
Housing surface material	uncoated
Seal material	NBR, conductive
Material lock	PA

### Environmental Product Compliance

China RoHS	Environmentally Friendly Use Period = 50 years
	For details about hazardous substances go to tab "Downloads", Category "Manufacturer's declaration"

## Drawings

# Housing - HC-STA-B24-CHWS-1TTP21-ELC-AL - 1412748

Dimensional drawing

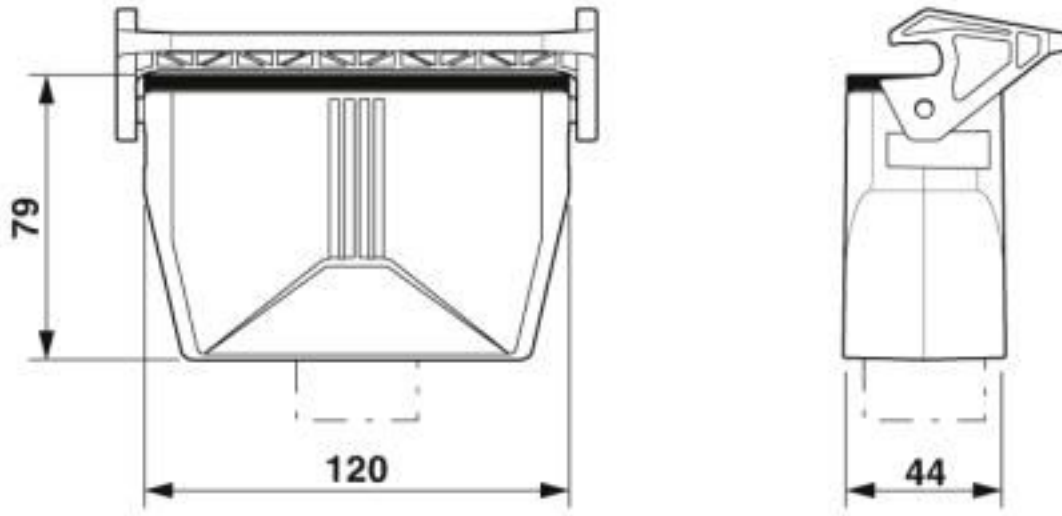

Dimensional drawing

## Classifications

eCl@ss

eCl@ss 10.0.1	27440202
eCl@ss 5.1	27261200
eCl@ss 6.0	27261200
eCl@ss 7.0	27440202
eCl@ss 8.0	27440202
eCl@ss 9.0	27440202

## ETIM

ETIM 5.0	EC000437
ETIM 6.0	EC000437
ETIM 7.0	EC000437

## UNSPSC

UNSPSC 13.2	31261501
UNSPSC 18.0	31261501
UNSPSC 19.0	31261501
UNSPSC 20.0	31261501
UNSPSC 21.0	31261501

# Housing - HC-STA-B24-CHWS-1TTP21-ELC-AL - 1412748

## Approvals

### Approvals

---

#### Approvals





UL Recognized / cUL Recognized / EAC / DNV GL / cULus Recognized

---

#### Ex Approvals

---

### Approval details

UL Recognized		<a href="http://database.ul.com/cgi-bin/XYV/template/LISEXT/1FRAME/index.htm">http://database.ul.com/cgi-bin/XYV/template/LISEXT/1FRAME/index.htm</a>	E255026
cUL Recognized		<a href="http://database.ul.com/cgi-bin/XYV/template/LISEXT/1FRAME/index.htm">http://database.ul.com/cgi-bin/XYV/template/LISEXT/1FRAME/index.htm</a>	E255026
EAC			RU C- DE.AI30.B.01102
DNV GL		<a href="https://approvalfinder.dnvgl.com/">https://approvalfinder.dnvgl.com/</a>	TAE000037S
cULus Recognized			

## Accessories

### Accessories

Full screw connection

## Housing - HC-STA-B24-CHWS-1TTP21-ELC-AL - 1412748

### Accessories

Cable gland - G-INS-PG21-M68N-NNES-S - 1411175



Cable gland, cable gland material: Nickel-plated brass, external cable diameter 13 mm ... 18 mm, shielding: no, connecting thread: Pg21, color: silver, with O-ring

---

Cable gland - G-INSEC-PG21-M68N-NNES-S - 1411200



Cable gland, cable gland material: Nickel-plated brass, external cable diameter 13 mm ... 18 mm, shielding: yes, connecting thread: Pg21, color: silver, with O-ring

---

### Housing latches

Replacement part - HC-STA-B24-SL-PLBK - 1412885



Single locking latch for B24 housing, HC-EVO...AL and HC-STA...AL

---

### Labeled device marker

Plastic label - US-EMLP (20X9) CUS - 0830085



Plastic label, can be ordered: By card, white, labeled according to customer specifications, mounting type: adhesive, lettering field size: 20 x 9 mm, Number of individual labels: 75

---

### Seal

## Housing - HC-STA-B24-CHWS-1TTP21-ELC-AL - 1412748

### Accessories

Profile gasket - HC-B24-SP-CBK - 1411482



Profile gasket for HEAVYCON EVO supporting base element type B24, conductive

---

---