

Contact insert - HC-D 25-I-CT-F-Z - 1411481

Please be informed that the data shown in this PDF Document is generated from our Online Catalog. Please find the complete data in the user's documentation. Our General Terms of Use for Downloads are valid (<http://phoenixcontact.com/download>)



HEAVYCON socket insert, D25 series, 25-pos., crimp connection, with special printing (row C pos. 1 is printed with the letter Z)



COMPLETE™

Key Commercial Data

Packing unit	1 pc
GTIN	 4 046356 921831
GTIN	4046356921831
Weight per Piece (excluding packing)	48.000 g
Custom tariff number	85389099
Country of origin	China

Technical data

General

Note	For HEAVYCON housing type D25, CK1,6-ED crimp contacts (crimp contacts not supplied as standard)
	Connectors may be operated only when there is no load/voltage.
	It is imperative that guide pins (HC-CST) and sockets (HC-CBU) are used to prevent tip collision due to misalignment.
Connection method	Crimp connection
Torque	0.7 Nm ... 1 Nm (PE connection)
	0.5 Nm ... 0.8 Nm (Mounting screws for mounting in the HEAVYCON housing)
Degree of pollution	3
Overvoltage category	III
Number of positions	25+PE

Contact insert - HC-D 25-I-CT-F-Z - 1411481

Technical data

General

Insertion/withdrawal cycles	≥ 500
Size	D25
	D50
Conductor cross section	0.14 mm ² ... 2.5 mm ²
Connection cross section AWG	26 ... 14
Stripping length of the individual wire	8 mm
Assembly instructions	To ensure correct use, installation in housing with IP54 protection or better is required

Ambient conditions

Ambient temperature (operation)	-40 °C ... 125 °C (including heating up of contacts)
---------------------------------	--

Material data

Contact material	Copper alloy
Contact surface material	Ag (alternatively Au)
Contact carrier material	PA

Electrical characteristics

Rated voltage (III/3)	250 V
Rated surge voltage	4 kV
Rated current	10 A

Standards and Regulations

Constructional and testing regulations	DIN VDE 0627/86
	DIN VDE 0110/02.79
	DIN VDE 0110-1/04.97
	IEC 60664-1, DIN IEC 60512
	IEC 60352
Flammability rating according to UL 94	V0

Drawings

Contact insert - HC-D 25-I-CT-F-Z - 1411481

Schematic diagram

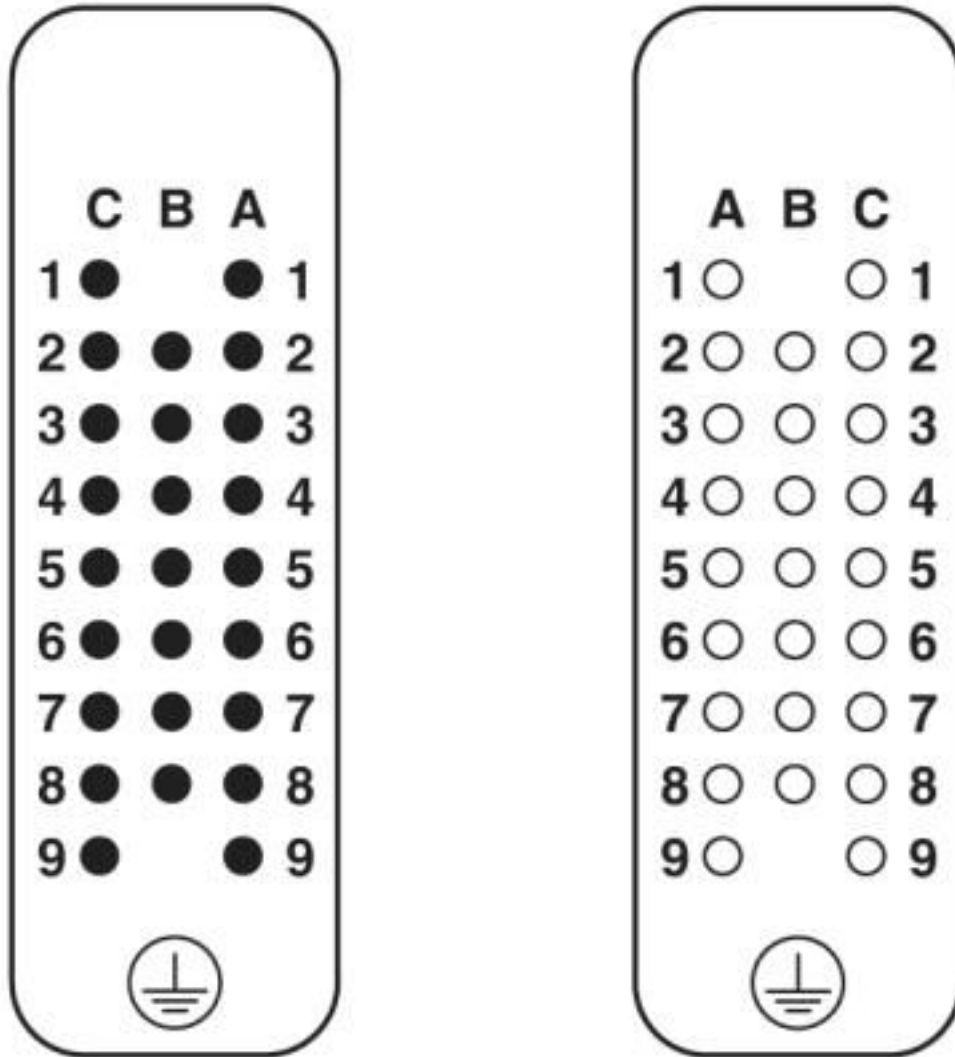

Connector pin assignment connection side: Left pin; right socket

Contact insert - HC-D 25-I-CT-F-Z - 1411481

Diagram

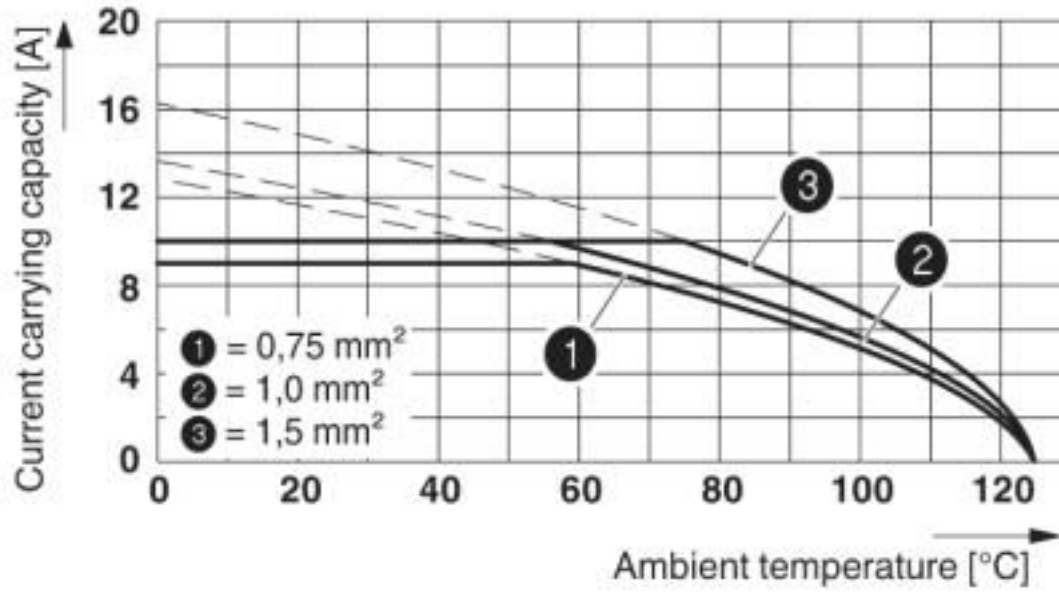

Derating diagram: HC-D...C series

Dimensional drawing

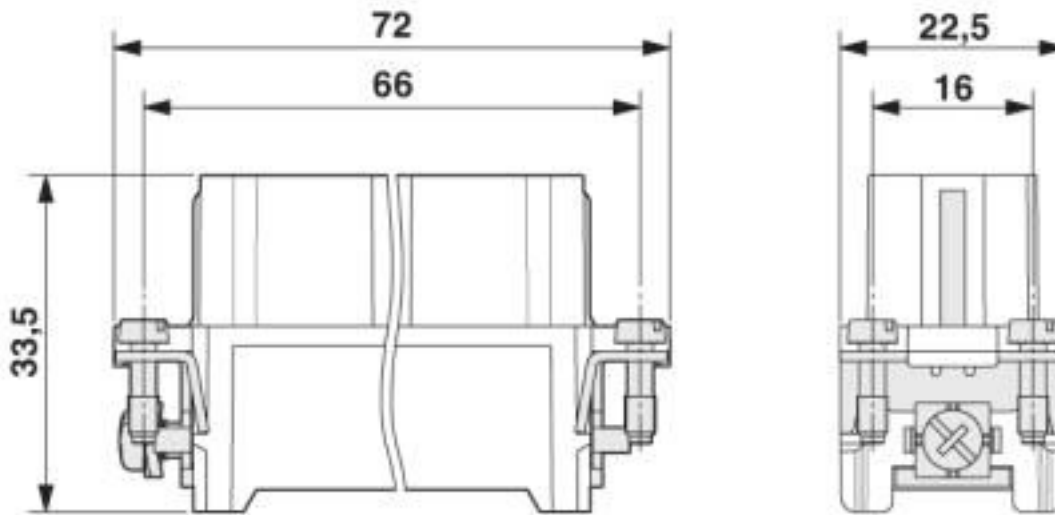

Female insert

Contact insert - HC-D 25-I-CT-F-Z - 1411481

Dimensional drawing

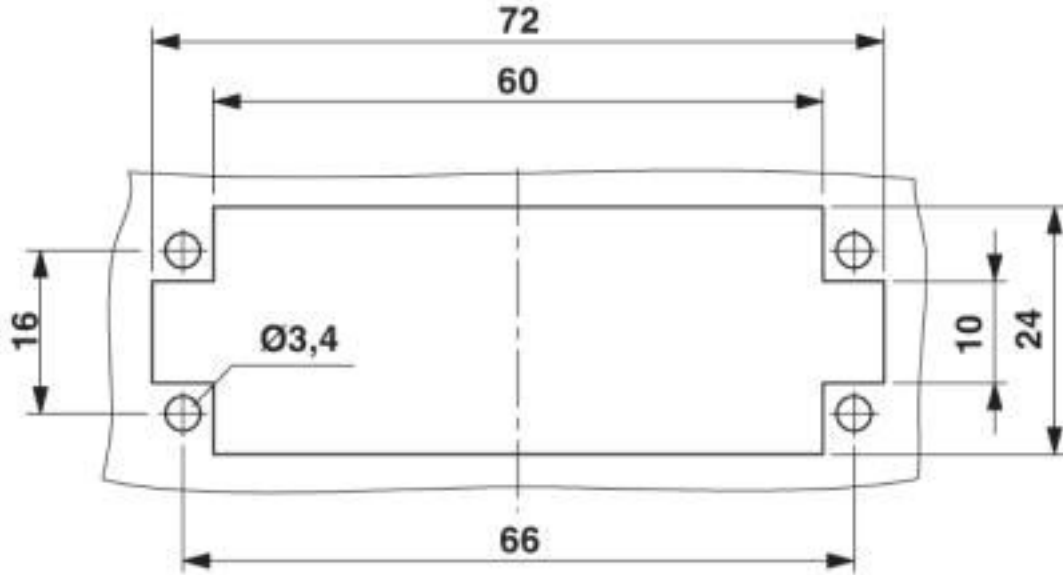

Mounting cutout when used without housing

Classifications

eCl@ss

eCl@ss 10.0.1	27440205
eCl@ss 5.1	27261200
eCl@ss 6.0	27261200
eCl@ss 7.0	27440205
eCl@ss 8.0	27440205
eCl@ss 9.0	27440205

ETIM

ETIM 4.0	EC002498
ETIM 5.0	EC000438
ETIM 6.0	EC000438
ETIM 7.0	EC000438

UNSPSC

UNSPSC 13.2	39121522
UNSPSC 18.0	39121522
UNSPSC 19.0	39121522
UNSPSC 20.0	39121522

Contact insert - HC-D 25-I-CT-F-Z - 1411481

Classifications

UNSPSC

UNSPSC 21.0	39121522
-------------	----------

Approvals

Approvals

Approvals

CSA / UL Recognized / EAC / DNV GL / EAC

Ex Approvals

Approval details

CSA		http://www.csagroup.org/services-industries/product-listing/	13631
Nominal voltage UN		600 V	
Nominal current IN		8 A	
mm ² /AWG/kcmil		14	

UL Recognized		http://database.ul.com/cgi-bin/XYV/template/LISEXT/1FRAME/index.htm	FILE E 118976
Nominal voltage UN		600 V	
Nominal current IN		10 A	
mm ² /AWG/kcmil		14	

EAC			RU C- DE.AI30.B.01102
-----	---	--	--------------------------

DNV GL		https://approvalfinder.dnvgl.com/	TAE000037S
--------	---	---	------------

Contact insert - HC-D 25-I-CT-F-Z - 1411481

Approvals

EAC



RU C-
DE.BL08.B.00511

Accessories

Accessories

Coding element

Coding element - HC-CST - 1676857



Coding peg for coding up to 16 connectors

Coding element - HC-CBU - 1676860



Coding socket for coding up to 16 connectors

Coding bolt - HC-CB - 1772722



Coding pin, prevents mismatching of up to six connectors with an identical number of positions

Dummy socket - CK1,6-ED-BB - 1645888



Dummy socket for contact carrier with turned CK 1,6-ED.. female contacts

Crimp contact

Contact insert - HC-D 25-I-CT-F-Z - 1411481

Accessories

Crimp contact - CK1,6-ED-0,37BU AG - 1663394



Turned 1.6 crimp contact, individual female contact, core diameter 0.14 to 0.37 mm², silver-plated

Crimp contact - CK1,6-ED-0,50BU AG - 1663404



Turned 1.6 crimp contact, individual female contact, core diameter 0.5 mm², silver-plated

Crimp contact - CK1,6-ED-0,75BU AG - 1663417



Turned 1.6 crimp contact, individual female contact, core diameter 0.75 mm², silver-plated

Crimp contact - CK1,6-ED-1,00BU AG - 1663420



Turned 1.6 crimp contact, individual female contact, core diameter 0.75 to 1.00 mm², silver-plated

Crimp contact - CK1,6-ED-1,50BU AG - 1663433



Turned 1.6 crimp contact, individual female contact, core diameter 1.5 mm², silver-plated

Contact insert - HC-D 25-I-CT-F-Z - 1411481

Accessories

Crimp contact - CK1,6-ED-2,50BU AG - 1663446



Turned 1.6 crimp contact, individual female contact, core diameter 2.5 mm², silver-plated

Crimp contact - CK1,6-ED-0,37BU AU - 1674969



Turned 1.6 crimp contact, individual female contact, core diameter 0.14 to 0.37 mm², gold-plated

Crimp contact - CK1,6-ED-0,50BU AU - 1674480



Turned 1.6 crimp contact, individual female contact, core diameter 0.5 mm², gold-plated

Crimp contact - CK1,6-ED-0,75BU AU - 1672440



Turned 1.6 crimp contact, individual female contact, core diameter 0.75 mm², gold-plated

Crimp contact - CK1,6-ED-1,00BU AU - 1674943



Turned 1.6 crimp contact, individual female contact, core diameter 0.75 to 1.00 mm², gold-plated

Contact insert - HC-D 25-I-CT-F-Z - 1411481

Accessories

Crimp contact - CK1,6-ED-1,50BU AU - 1674930



Turned 1.6 crimp contact, individual female contact, core diameter 1.5 mm², gold-plated

Crimp contact - CK1,6-ED-2,50BU AU - 1674985



Turned 1.6 crimp contact, individual female contact, core diameter 2.5 mm², gold-plated

Crimping tool

Crimping pliers - CRIMPFOX-TC 4 - 1212113



Crimping pliers, for CK 1,6-ED..., CK 2,5-ED..., CK 4,0-ED... turned contacts, 4 marked die stations, unlockable pressure lock, lateral entry, incl. positioning tool

Mounting material

Screw - HC-A-PES - 1584868



PE screw for contact inserts of A series

Universal tools

Contact insert - HC-D 25-I-CT-F-Z - 1411481

Accessories

Contact removal tool - UNIFOX RT-CK 1.6 - 1072069



Contact removal tool, for turned and rolled CK- 1.6-... contacts

Additional products

Contact insert - HC-D 25-I-CT-M-Z - 1411478



HEAVYCON pin insert, D25 series, 25-pos., crimp connection, with special printing (row C pos. 1 is printed with the letter Z)