

EMV nut - A-INLE-PG16-N-S - 1411279

Please be informed that the data shown in this PDF Document is generated from our Online Catalog. Please find the complete data in the user's documentation. Our General Terms of Use for Downloads are valid (<http://phoenixcontact.com/download>)

EMV nut, material: Brass, nickel-plated, for threads Pg16, color: silver



Key Commercial Data

Packing unit	1 pc
GTIN	 4 046356 924108
GTIN	4046356924108
Weight per Piece (excluding packing)	6.200 g
Custom tariff number	74199990
Country of origin	Germany

Technical data

Dimensions

Length	4.7 mm
Connecting thread diameter	22.5 mm
Wrench size, counter nut	26 mm
Hexagon angular dimension	29 mm

Ambient conditions

Ambient temperature (operation)	-70 °C ... 220 °C
---------------------------------	-------------------

General

Material	Brass, nickel-plated
Thread type on connection side	Pg16
Color	silver

EMV nut - A-INLE-PG16-N-S - 1411279

Technical data

General

Assembly instructions	for EMC cable glands, for removing a non-conductive surface coating
-----------------------	---

Standards and Regulations

Halogen-free	yes
--------------	-----

Environmental Product Compliance

REACH SVHC	Lead 7439-92-1
China RoHS	Environmentally Friendly Use Period = 50 years
	For details about hazardous substances go to tab "Downloads", Category "Manufacturer's declaration"

Drawings

Dimensional drawing

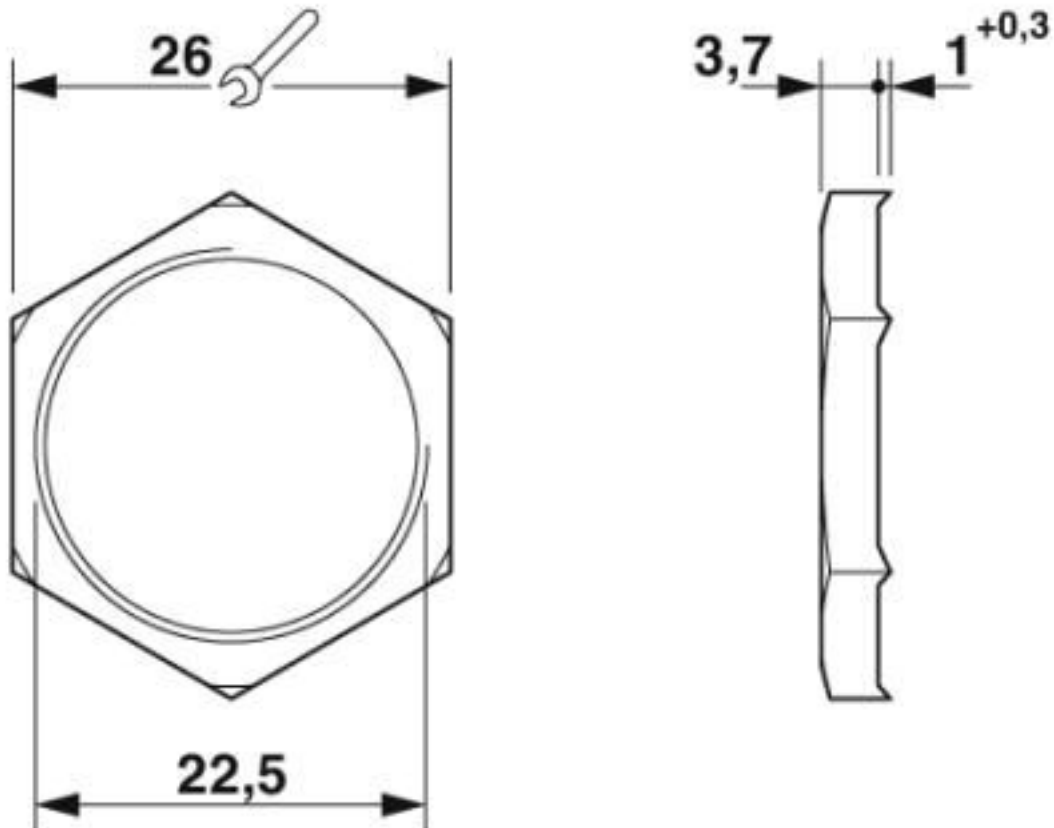

EMV nut - A-INLE-PG16-N-S - 1411279

Classifications

eCl@ss

eCl@ss 10.0.1	27144424
eCl@ss 4.0	27141200
eCl@ss 4.1	27141200
eCl@ss 5.0	27149100
eCl@ss 5.1	27149100
eCl@ss 6.0	27149100
eCl@ss 7.0	27069219
eCl@ss 8.0	27069219
eCl@ss 9.0	27144424

ETIM

ETIM 4.0	EC000032
ETIM 5.0	EC000129
ETIM 6.0	EC000940
ETIM 7.0	EC000940

UNSPSC

UNSPSC 13.2	31161716
UNSPSC 18.0	31161716
UNSPSC 19.0	31161716
UNSPSC 20.0	31161716
UNSPSC 21.0	31161716