

## Counter nut - A-INL-M20-S-S - 1411249

Please be informed that the data shown in this PDF Document is generated from our Online Catalog. Please find the complete data in the user's documentation. Our General Terms of Use for Downloads are valid (<http://phoenixcontact.com/download>)

Counter nut, material: Stainless steel 1.4305, for threads M20 x 1.5, color: silver



RoHS

### Key Commercial Data

Packing unit	1 pc
GTIN	 4 046356 923811
GTIN	4046356923811
Weight per Piece (excluding packing)	2.000 g
Custom tariff number	73269098
Country of origin	Germany

### Technical data

#### Dimensions

Length	3 mm
Connecting thread diameter	20 mm
Wrench size, counter nut	24 mm
Hexagon angular dimension	27 mm

#### Ambient conditions

Ambient temperature (operation)	-70 °C ... 220 °C
---------------------------------	-------------------

#### General

Material	Stainless steel 1.4305
Thread type on connection side	M20 x 1.5
Color	silver

# Counter nut - A-INL-M20-S-S - 1411249

## Technical data

### Standards and Regulations

Halogen-free	yes
--------------	-----

### Environmental Product Compliance

China RoHS	Environmentally friendly use period: unlimited = EFUP-e
	No hazardous substances above threshold values

## Drawings

Dimensional drawing

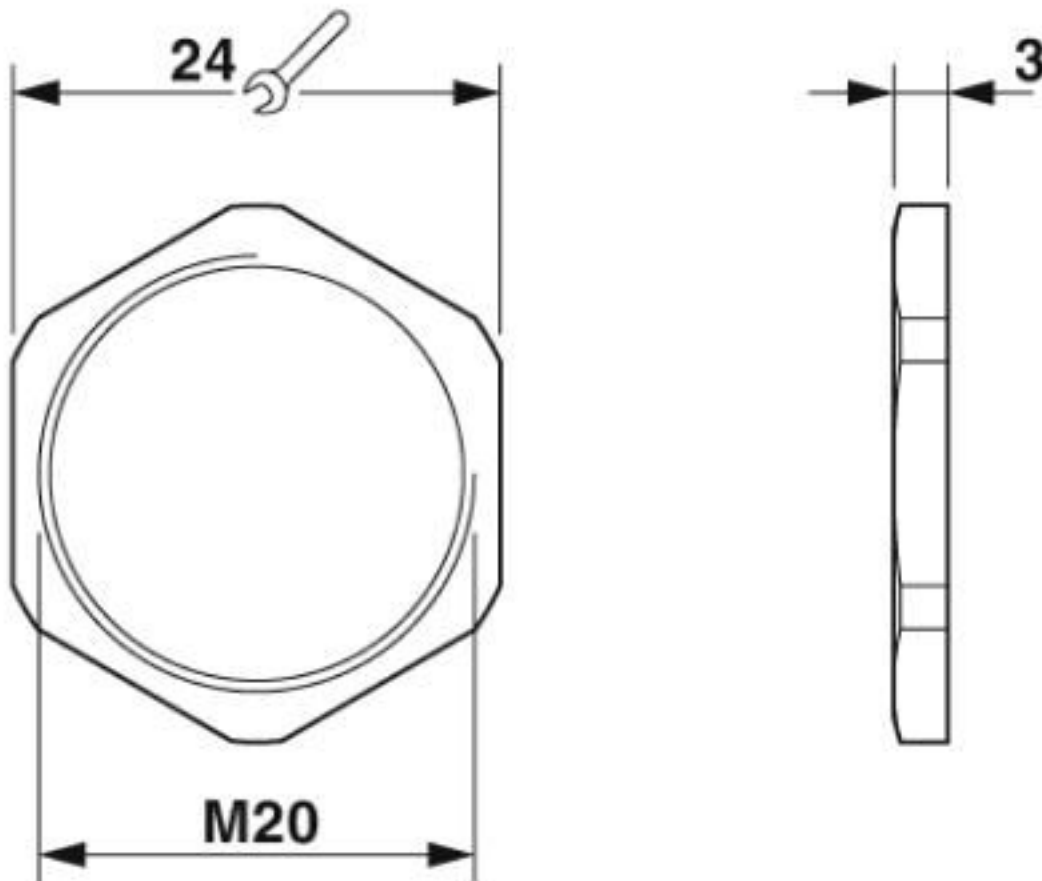

Dimensional drawing

## Counter nut - A-INL-M20-S-S - 1411249

### Classifications

#### eCl@ss

eCl@ss 10.0.1	27144424
eCl@ss 4.0	27141200
eCl@ss 4.1	27141200
eCl@ss 5.0	27149100
eCl@ss 5.1	27149100
eCl@ss 6.0	27149100
eCl@ss 7.0	27069219
eCl@ss 8.0	27069219
eCl@ss 9.0	27144424

#### ETIM

ETIM 4.0	EC000032
ETIM 5.0	EC000129
ETIM 6.0	EC000940
ETIM 7.0	EC000940

#### UNSPSC

UNSPSC 13.2	31161716
UNSPSC 18.0	31161716
UNSPSC 19.0	31161716
UNSPSC 20.0	31161716
UNSPSC 21.0	31161716