

Counter nut - A-INL-M12-P-BK - 1411213

Please be informed that the data shown in this PDF Document is generated from our Online Catalog. Please find the complete data in the user's documentation. Our General Terms of Use for Downloads are valid (<http://phoenixcontact.com/download>)

Counter nut, material: PA, for threads M12 x 1.5, color: jet black RAL 9005



RoHS

Key Commercial Data

Packing unit	1 pc
GTIN	 4 046356 923453
GTIN	4046356923453
Weight per Piece (excluding packing)	2.000 g
Custom tariff number	39269097
Country of origin	Turkey

Technical data

Dimensions

Length	5 mm
Connecting thread diameter	12 mm
Wrench size, counter nut	18 mm
Hexagon angular dimension	19.5 mm

Ambient conditions

Ambient temperature (operation)	-40 °C ... 100 °C
---------------------------------	-------------------

General

Material	PA
Flammability rating according to UL 94	V2
Thread type on connection side	M12 x 1.5

Counter nut - A-INL-M12-P-BK - 1411213

Technical data

General

Color	jet black RAL 9005
-------	--------------------

Standards and Regulations

Halogen-free	yes
Flammability rating according to UL 94	V2

Environmental Product Compliance

China RoHS	Environmentally friendly use period: unlimited = EFUP-e
	No hazardous substances above threshold values

Drawings

Dimensional drawing

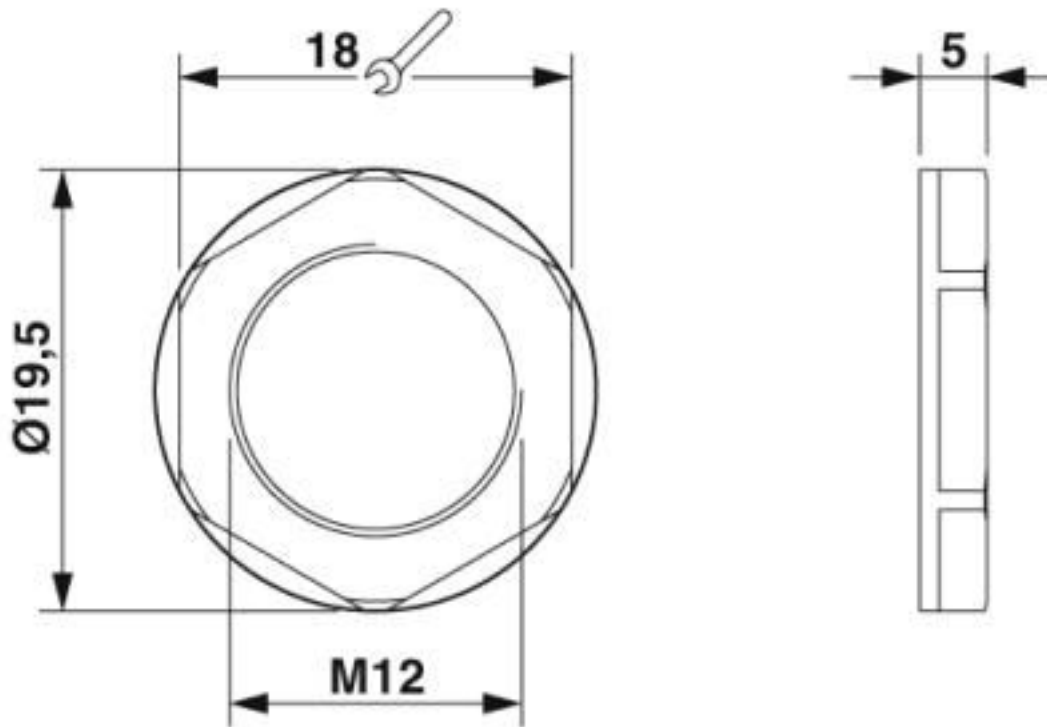

Classifications

eCl@ss

eCl@ss 10.0.1	27144424
eCl@ss 4.0	27141200

Counter nut - A-INL-M12-P-BK - 1411213

Classifications

eCl@ss

eCl@ss 4.1	27141200
eCl@ss 5.0	27149100
eCl@ss 5.1	27149100
eCl@ss 6.0	27149100
eCl@ss 7.0	27069219
eCl@ss 8.0	27069219
eCl@ss 9.0	27144424

ETIM

ETIM 4.0	EC000032
ETIM 5.0	EC000129
ETIM 6.0	EC000940
ETIM 7.0	EC000940

UNSPSC

UNSPSC 13.2	31161716
UNSPSC 18.0	31161716
UNSPSC 19.0	31161716
UNSPSC 20.0	31161716
UNSPSC 21.0	31161716