

Cable gland - G-INSEC-PG48-L68N-NNES-S - 1411204

Please be informed that the data shown in this PDF Document is generated from our Online Catalog. Please find the complete data in the user's documentation. Our General Terms of Use for Downloads are valid (<http://phoenixcontact.com/download>)



Cable gland, cable gland material: Nickel-plated brass, external cable diameter 34 mm ... 44 mm, shielding: yes, connecting thread: Pg48, color: silver, with O-ring



Key Commercial Data

Packing unit	1 pc
GTIN	 4 046356 923361
GTIN	4046356923361
Weight per Piece (excluding packing)	380.000 g
Custom tariff number	74199990
Country of origin	Turkey

Technical data

Dimensions

Length	65 mm
Wrench size, union nut	64 mm
Wrench size, support	64 mm
Hexagon angular dimension	70 mm
Length of the connecting thread	14 mm
Feed-through hole diameter	59.4 mm ... 59.7 mm
External cable diameter	34 mm ... 44 mm
Cable diameter without cable sheath	31 mm (Diameter of braided shield)

Ambient conditions

Degree of protection (IP)	IP68
Ambient temperature (operation)	-40 °C ... 100 °C (static)

Cable gland - G-INSEC-PG48-L68N-NNES-S - 1411204

Technical data

General

No. of conductors	1
Cable gland material	Nickel-plated brass
Material, insert	Polyamide 6
Cable seal material	CR
O-ring material	Perbunan
Shielded	yes
Thread type on connection side	Pg48
Torque	35 Nm (Union nut: EN 62444)
	35 Nm (Support: EN 62444)
Color	silver
Assembly instructions	1) Mount screw connection flange in the housing using the correct torque 2) Insert cable 3) Tighten union nut using the correct torque
Connection	<p>Method 1 Cut the outer sheath, but do not remove it. Feed the cable through the screw connection and then remove the outer sheath. Now pull the cable back until the connection is established between the cable shield and the contact spring.</p> <p>Method 2 Push the braided shield back around 15 ... 20 mm over the outer sheath. Insert the cables into the screw connection until the connection is established between the cable shield and the contact spring.</p>
Manufacturer	BIMED
Manufacturer Designation	BSEM-10

Standards and Regulations

Halogen-free	no
Connection in acc. with standard	UL

Environmental Product Compliance

REACH SVHC	Lead 7439-92-1
China RoHS	Environmentally Friendly Use Period = 50 years
	For details about hazardous substances go to tab "Downloads", Category "Manufacturer's declaration"

Drawings

Cable gland - G-INSEC-PG48-L68N-NNES-S - 1411204

Dimensional drawing

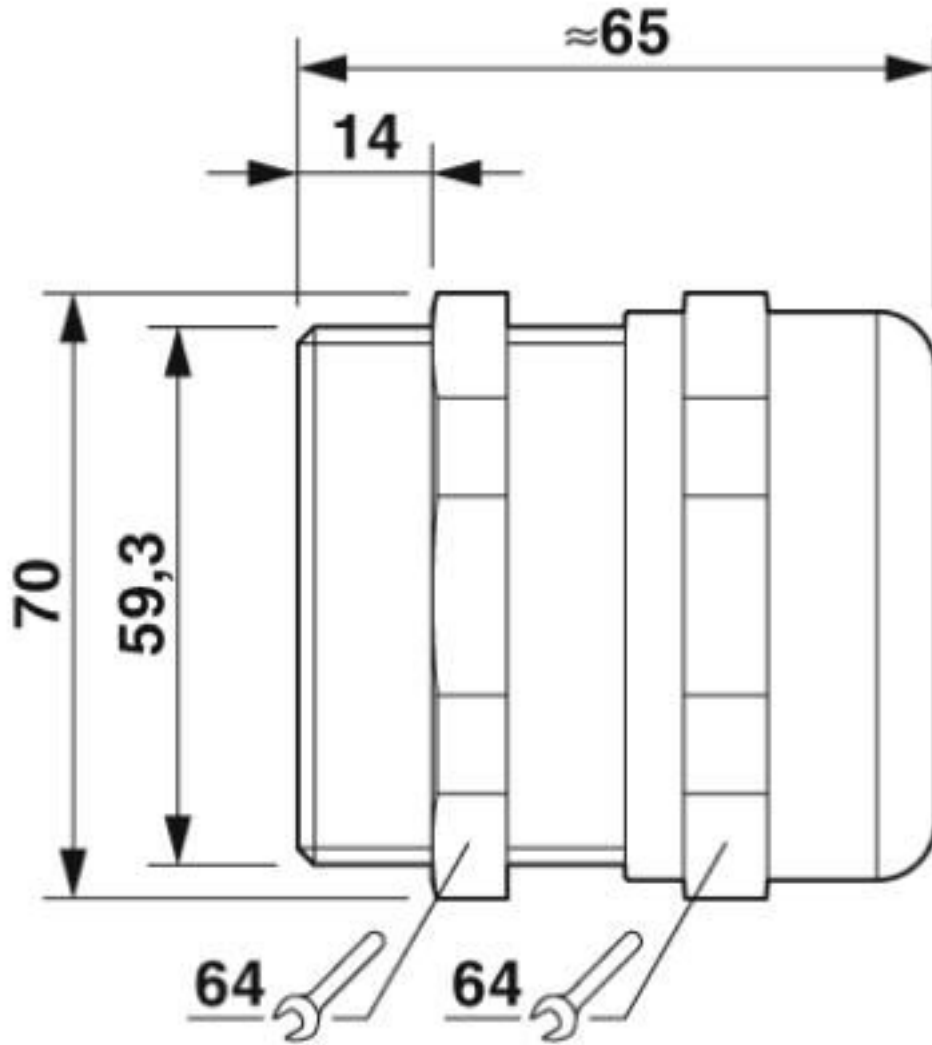

Dimensional drawing

Cable gland - G-INSEC-PG48-L68N-NNES-S - 1411204

Functional drawing

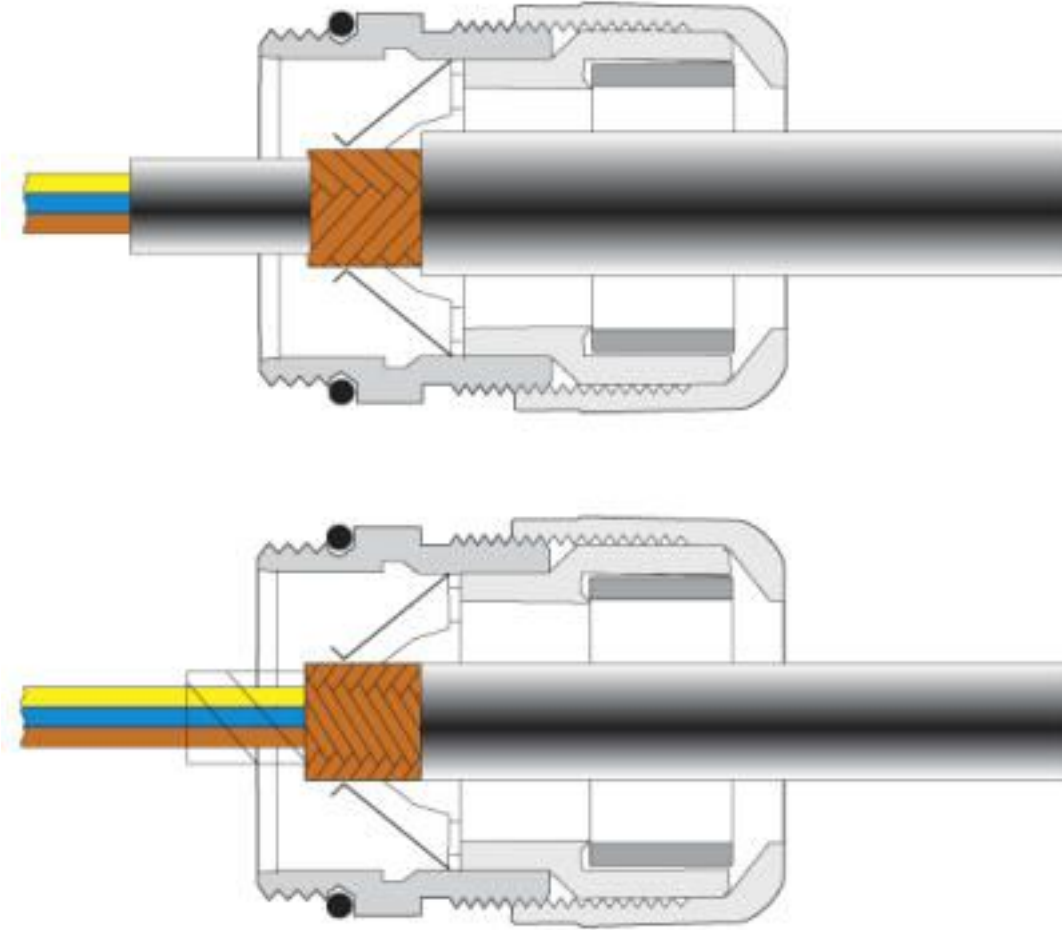

See assembly instruction

Classifications

eCl@ss

eCl@ss 10.0.1	27144432
eCl@ss 4.0	27141200
eCl@ss 4.1	27141200
eCl@ss 5.0	27149100
eCl@ss 5.1	27149100
eCl@ss 6.0	27149100
eCl@ss 7.0	27149109
eCl@ss 8.0	27149109

Cable gland - G-INSEC-PG48-L68N-NNES-S - 1411204

Classifications

eCl@ss

eCl@ss 9.0	27144432
------------	----------

ETIM

ETIM 4.0	EC000441
ETIM 5.0	EC000441
ETIM 6.0	EC000441
ETIM 7.0	EC000441

UNSPSC

UNSPSC 13.2	39121311
UNSPSC 18.0	39121311
UNSPSC 19.0	39121311
UNSPSC 20.0	39121311
UNSPSC 21.0	39121311

Accessories

Accessories

Sealing plugs

Closing cap - SEALING PLUG 35X35 RD - 1421865



Closing cap, material: PA, color: red