

Cable gland - G-ESSWU-M25-M66L-NTES-S - 1411092

Please be informed that the data shown in this PDF Document is generated from our Online Catalog. Please find the complete data in the user's documentation. Our General Terms of Use for Downloads are valid (<http://phoenixcontact.com/download>)



Cable gland, cable gland material: Nickel-plated brass, application: Ex, external cable diameter 18.2 mm ... 26.2 mm, shielding: yes, connecting thread: M25 x 1.5, color: silver

Product Description

Cable gland, for armored cables (SWA / AWA / PWA / STA / SWB / ASA / CY / SY)

Your advantages

- If space is restricted at the fixing location of the screw connection, the armor can be attached at a location where there is more room to move. Final assembly can then be easily completed in the restricted space conditions at the fixing location of the screw connection.
- Armor connected via PE cone
- Weatherproof sealing material

RoHS



Key Commercial Data

Packing unit	1 pc
Minimum order quantity	10 pc
GTIN	 4 046356 922050
GTIN	4046356922050
Weight per Piece (excluding packing)	314.000 g
Custom tariff number	74199990
Country of origin	United Kingdom

Technical data

Dimensions

Length	82 mm
Thread pitch	1.5 mm
Wrench size, union nut	37.5 mm

Cable gland - G-ESSWU-M25-M66L-NTES-S - 1411092

Technical data

Dimensions

Wrench size, support	37.5 mm
Hexagon angular dimension	41.3 mm
Length of the connecting thread	15 mm
External cable diameter	18.2 mm ... 26.2 mm
Armor connection method	Cone
Armor thickness	1.25 mm ... 1.6 mm (Stepped cone side (SWA/...))
	0 mm ... 1.1 mm (Grooved cone side (STA/...))
Cable diameter without armor	20 mm (Filler beneath the armor)
Cable types that can be used	Depending on the material of the housing wall (SWA/AWA/PWA/STA/ASA/CY/SY/SWB)

Ambient conditions

Degree of protection (IP)	IP66 (using the corresponding A-SEW-...P-W flat gasket)
	IP67 (using the corresponding A-SEW-...P-W flat gasket)
	IP68 (using the corresponding A-SEW-...P-W flat gasket)
Ambient temperature (operation)	-60 °C ... 130 °C (static)

General

Cable gland material	Nickel-plated brass
Cable seal material	EPDM
Thread type connection side	M25 x 1.5
Color	silver
Impact energy	20.00 J
Assembly instructions	With integrated grounding cones, sealed to IP66/IP67/IP68 thanks to the use of the A-SEW-25-P-W flat gasket (item 1411284)
Connection	If space is restricted at the fixing location of the screw connection, the armor can be attached at a location where there is more room to move. Final assembly can then be easily completed in the restricted space conditions at the fixing location of the screw connection.
Standards/specifications	EN 60079-0, -7, -15, -31
	IEC 60079-0, -7, -15, -31
	EN 50262
	BS 6121: Part 1:1989
	IEC 62444
Manufacturer	CMP
Manufacturer product number	25C2K1RA5
Manufacturer Designation	25 C2K N. PLTD GLAND
Suited for EX-applications	yes

Standards and Regulations

Standards/specifications	EN 60079-0, -7, -15, -31
--------------------------	--------------------------

Cable gland - G-ESSWU-M25-M66L-NTES-S - 1411092

Technical data

Standards and Regulations

	IEC 60079-0, -7, -15, -31
	EN 50262
	BS 6121: Part 1:1989
	IEC 62444
ATEX	Sira 13ATEX1070X
	Sira 13ATEX4076X
	Ex II 2G, II 1D, Ex e IIC Gb, Ex ta IIIC Da, Ex II 3G Ex nR IIC Gc
IECEX	IECEX SIR 13.0025X
	Ex e IIC Gb, Ex nR IIC Gc, Ex ta IIIC Da

Environmental Product Compliance

REACH SVHC	Lead 7439-92-1
China RoHS	Environmentally Friendly Use Period = 50 years
	For details about hazardous substances go to tab "Downloads", Category "Manufacturer's declaration"

Drawings

Cable gland - G-ESSWU-M25-M66L-NTES-S - 1411092

Dimensional drawing

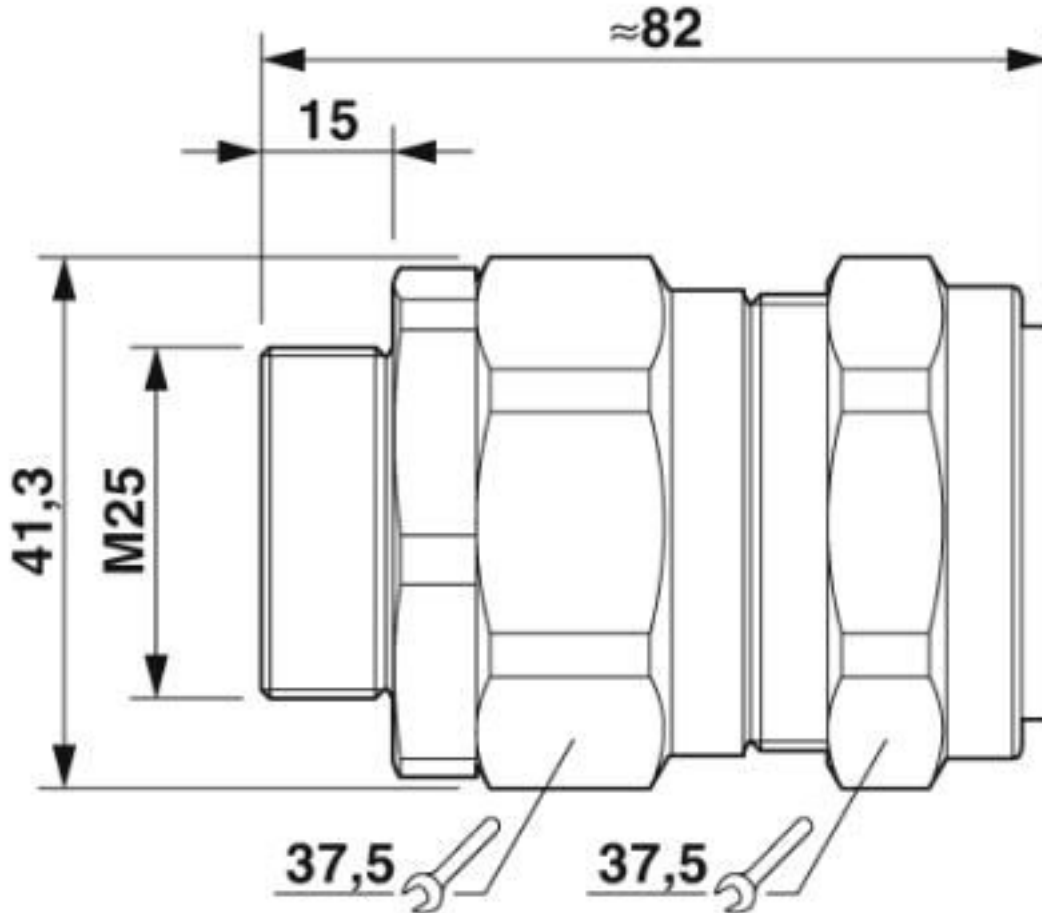

Dimensional drawing

Classifications

eCl@ss

eCl@ss 10.0.1	27144432
eCl@ss 4.0	27141200
eCl@ss 4.1	27141200
eCl@ss 5.0	27149100
eCl@ss 5.1	27149100
eCl@ss 6.0	27149100
eCl@ss 7.0	27149109
eCl@ss 8.0	27149109

Cable gland - G-ESSWU-M25-M66L-NTES-S - 1411092

Classifications

eCl@ss

eCl@ss 9.0	27144432
------------	----------

ETIM

ETIM 4.0	EC000441
ETIM 5.0	EC000441
ETIM 6.0	EC000441
ETIM 7.0	EC000441

UNSPSC

UNSPSC 13.2	39121311
UNSPSC 18.0	39121311
UNSPSC 19.0	39121311
UNSPSC 20.0	39121311
UNSPSC 21.0	39121311

Accessories

Accessories

Flat nut

Counter nut - A-INL-M25-N-S - 1411243



Counter nut, material: Brass, nickel-plated, for threads M25 x 1.5, color: silver

Seal

Flat gasket - A-SEW-25-P-W - 1411284



Flat gasket, material: Nylon, for threads M25, color: white