

Reducing adapter - REDUC-K-KV-M40/M32 BK - 1410738

Please be informed that the data shown in this PDF Document is generated from our Online Catalog. Please find the complete data in the user's documentation. Our General Terms of Use for Downloads are valid (<http://phoenixcontact.com/download>)



Reducing adapter, material: Polyamide fiberglass reinforced, connecting thread: M40 x 1.5, color: black, with flat gasket

Product Description

Reduced M40 to M32

Key Commercial Data

Packing unit	1 pc
Minimum order quantity	10 pc
GTIN	 4 046356 873192
GTIN	4046356873192
Weight per Piece (excluding packing)	14.000 g
Custom tariff number	39269097
Country of origin	Germany

Technical data

Dimensions

Length	16 mm
Length without connecting thread	6 mm
Connecting thread diameter	40 mm
Wrench size, union nut	46 mm
Hexagon angular dimension	50.5 mm
Length of the connecting thread	10 mm

Ambient conditions

Degree of protection (IP)	IP65 (Depends on the screw connection used)
---------------------------	---

Reducing adapter - REDUC-K-KV-M40/M32 BK - 1410738

Technical data

Ambient conditions

Ambient temperature (operation)	-30 °C ... 100 °C
---------------------------------	-------------------

General

Material	Polyamide fiberglass reinforced
Outer thread	M40
Internal thread	M32
Torque	5 Nm ... 7.5 Nm
Flammability rating according to UL 94	HB
Color	black

Standards and Regulations

Halogen-free	no
Flammability rating according to UL 94	HB

Environmental Product Compliance

China RoHS	Environmentally friendly use period: unlimited = EFUP-e
	No hazardous substances above threshold values

Drawings

Reducing adapter - REDUC-K-KV-M40/M32 BK - 1410738

Dimensional drawing

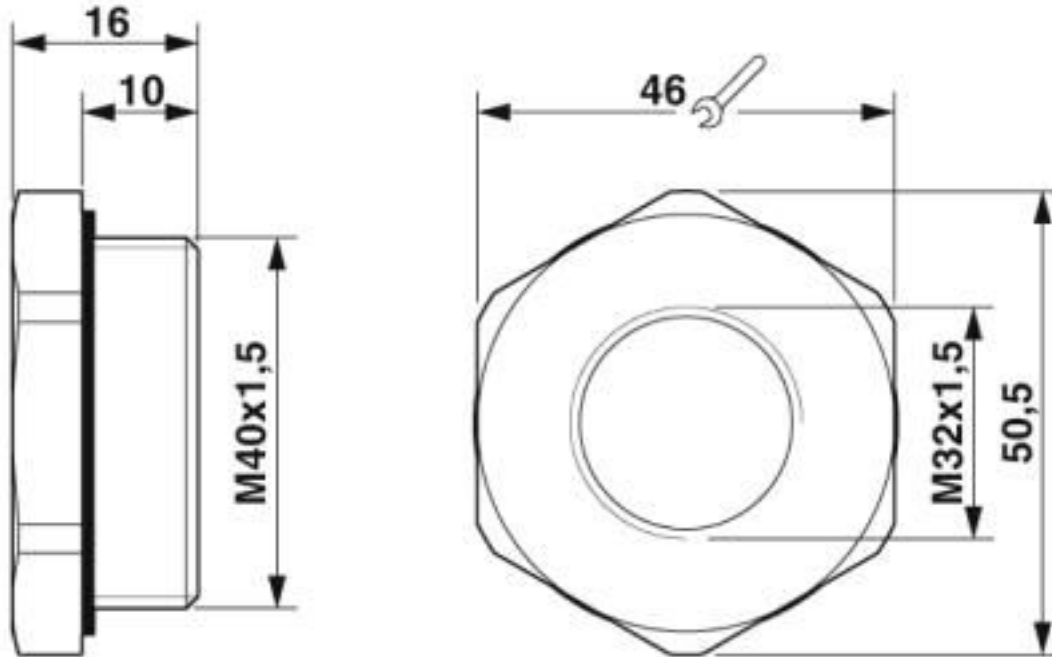

Dimensional drawing

Classifications

eCl@ss

eCl@ss 10.0.1	27440201
eCl@ss 4.0	27141200
eCl@ss 4.1	27141200
eCl@ss 5.0	27149100
eCl@ss 5.1	27149100
eCl@ss 6.0	27149100
eCl@ss 7.0	27149109
eCl@ss 8.0	27149109
eCl@ss 9.0	27440201

ETIM

ETIM 4.0	EC000441
ETIM 5.0	EC000441
ETIM 6.0	EC002309
ETIM 7.0	EC002309

Reducing adapter - REDUC-K-KV-M40/M32 BK - 1410738

Classifications

UNSPSC

UNSPSC 6.01	30211808
UNSPSC 7.0901	39121408
UNSPSC 11	39121408
UNSPSC 12.01	39121408
UNSPSC 13.2	39121311
UNSPSC 18.0	31261501
UNSPSC 19.0	31261501
UNSPSC 20.0	31261501
UNSPSC 21.0	31261501