

Cable sleeve - CES-SRG-BK-2X9 - 1410411

Please be informed that the data shown in this PDF Document is generated from our Online Catalog. Please find the complete data in the user's documentation. Our General Terms of Use for Downloads are valid (<http://phoenixcontact.com/download>)



Cable sleeve, no. of conductors: 2, length: 29.5 mm, width: 19.5 mm, height: 17 mm, external cable diameter: 2x 8 mm ... 9 mm , color: black

Product Description

Slotted cable sleeve

Key Commercial Data

Packing unit	1 pc
Minimum order quantity	10 pc
GTIN	 4 046356 776349
GTIN	4046356776349
Weight per Piece (excluding packing)	8.000 g
Custom tariff number	40169300
Country of origin	Taiwan

Technical data

Dimensions

External cable diameter	2x 8 mm ... 9 mm
Length	29.5 mm
Width	19.5 mm
Height	17 mm

Ambient conditions

Degree of protection	IP54
Ambient temperature (operation)	-40 °C ... 125 °C (static)

Cable sleeve - CES-SRG-BK-2X9 - 1410411

Technical data

General

No. of conductors	2
Material	NBR
	NBR
Color	black

Environmental Product Compliance

China RoHS	Environmentally friendly use period: unlimited = EFUP-e
	No hazardous substances above threshold values

Drawings

Dimensional drawing

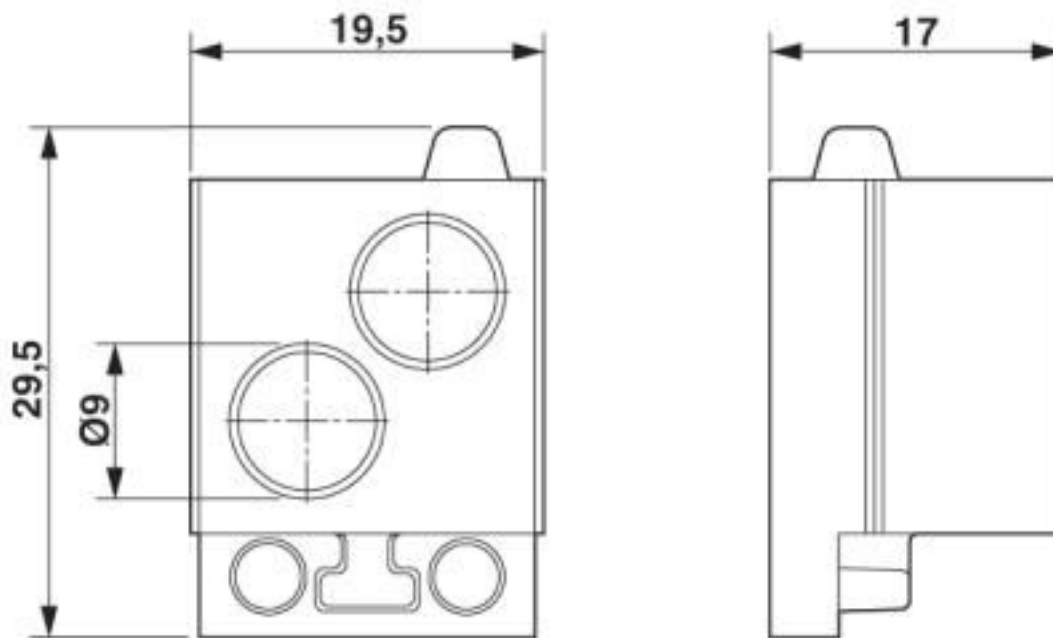

Dimensional drawing

Classifications

eCl@ss

eCl@ss 10.0.1	27144425
eCl@ss 4.0	27081000
eCl@ss 4.1	27081000
eCl@ss 5.0	27081000

Cable sleeve - CES-SRG-BK-2X9 - 1410411

Classifications

eCl@ss

eCl@ss 5.1	27081000
eCl@ss 6.0	27081000
eCl@ss 7.0	27069220
eCl@ss 8.0	27069220
eCl@ss 9.0	27144425

ETIM

ETIM 3.0	EC000879
ETIM 4.0	EC002498
ETIM 5.0	EC000451
ETIM 6.0	EC000451
ETIM 7.0	EC000451

UNSPSC

UNSPSC 6.01	30212109
UNSPSC 7.0901	39121708
UNSPSC 11	39121708
UNSPSC 12.01	39121708
UNSPSC 13.2	30181807
UNSPSC 18.0	39121448
UNSPSC 19.0	39121448
UNSPSC 20.0	39121448
UNSPSC 21.0	39121448

Approvals

Approvals

Approvals

DNV GL

Ex Approvals

Approval details

Cable sleeve - CES-SRG-BK-2X9 - 1410411

Approvals

DNV GL



<https://approvalfinder.dnvgl.com/>

TAE00003VJ