

Housing - HC-ADV-B06-HHWH-1SGM25-PL - 1404226

Please be informed that the data shown in this PDF Document is generated from our Online Catalog. Please find the complete data in the user's documentation. Our General Terms of Use for Downloads are valid (<http://phoenixcontact.com/download>)



Sleeve housing B6, with screw locking, material: PA, cable outlets: 1, lateral, height: 93.7 mm, cable gland: with, support sleeve: no, 1x M25, Standard

Your advantages

- ✓ Integrated screw connection
- ✓ Lower costs than metal version
- ✓ Can also be used without panel mounting base
- ✓ Labeling option using 9 x 20 mm marking label
- ✓ Low weight
- ✓ Lower risk of condensation
- ✓ Both contact insert PE sheets are connected by means of a metal frame integrated in the sleeve housing
- ✓ Capacitive PE, even when connected at an angle
- ✓ Completely corrosion-resistant
- ✓ Halogen-free plastic
- ✓ Impact test according to IK 08



Key Commercial Data

Packing unit	1 pc
GTIN	 4 046356 681971
GTIN	4046356681971
Weight per Piece (excluding packing)	118.200 g
Custom tariff number	85366990
Country of origin	Germany

Housing - HC-ADV-B06-HHWH-1SGM25-PL - 1404226

Technical data

Dimensions

Height	93.7 mm
Width	57 mm
Length	92 mm
Wrench size, union nut	26 mm
External cable diameter	9 mm ... 17 mm
Length of the assembly cutout	52 mm
Width of the assembly cutout	35 mm

Ambient conditions

Degree of protection of housing (IP)	IP66
	IP67
Ambient temperature (operation)	-40 °C ... 100 °C

General

Note	for contact inserts HC-B06, BB10, DD24, M
Size	B6
Housing type	Sleeve housing
Color	black
Locking type	with screw locking
Torque	3 Nm (Locking screw)
Fixing screws	M6 (screw head: 5 mm Allen screw)
No. of cable outlets	1
Cable outlet	lateral
Screw connection	with
Type of the screw connection	1x M25
Housing material	PA
Seal material	NBR
Cable seal material	NBR
Material lock	Stainless steel
Material of locking screw	Stainless steel
Flammability rating according to UL 94	V0
Assembly instructions	M6 locking screw, with 5 mm Allen screw head

Standards and Regulations

Flammability rating according to UL 94	V0
--	----

Environmental Product Compliance

China RoHS	Environmentally friendly use period: unlimited = EFUP-e
------------	---

Housing - HC-ADV-B06-HHWH-1SGM25-PL - 1404226

Technical data

Environmental Product Compliance

No hazardous substances above threshold values
--

Drawings

Dimensional drawing

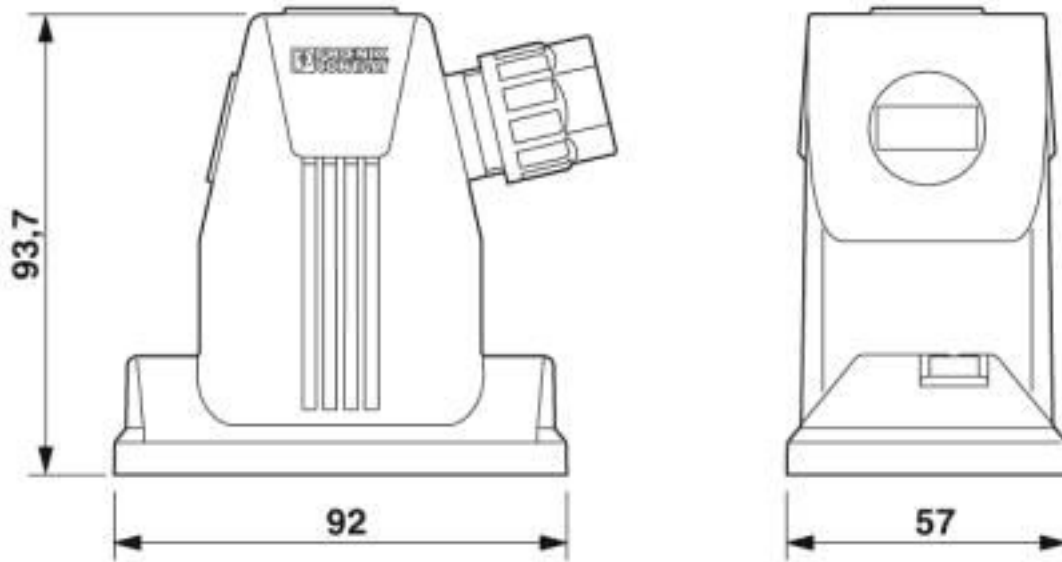

Dimensional drawing

Housing - HC-ADV-B06-HHWH-1SGM25-PL - 1404226

Dimensional drawing

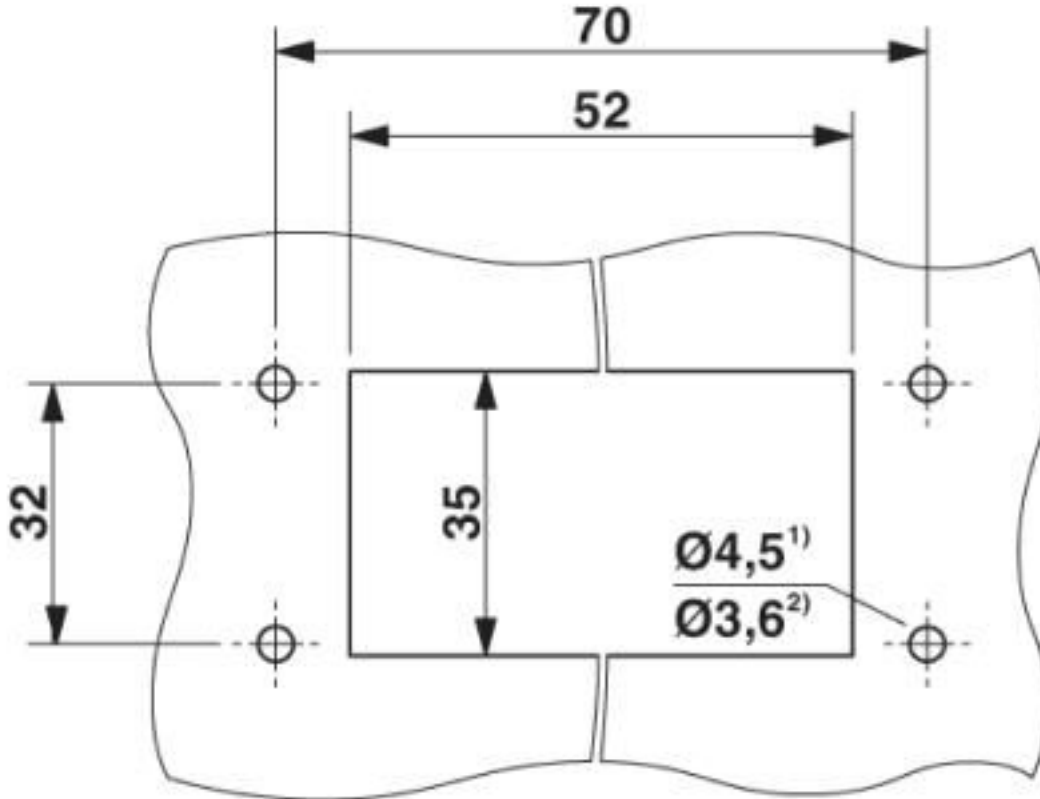

Mounting cutout

1) when M4 screws are used

2) when self-tapping Torx® screws are used (Torx® 20, M4)

Classifications

eCl@ss

eCl@ss 10.0.1	27440202
eCl@ss 4.0	27140800
eCl@ss 4.1	27140800
eCl@ss 5.0	27143400
eCl@ss 5.1	27261200
eCl@ss 6.0	27261200
eCl@ss 7.0	27440202
eCl@ss 8.0	27440202
eCl@ss 9.0	27440202

Housing - HC-ADV-B06-HHWH-1SGM25-PL - 1404226

Classifications

ETIM

ETIM 3.0	EC000516
ETIM 4.0	EC000437
ETIM 5.0	EC000437
ETIM 6.0	EC000437
ETIM 7.0	EC000437

UNSPSC

UNSPSC 6.01	31261502
UNSPSC 7.0901	31261502
UNSPSC 11	31261502
UNSPSC 12.01	31261502
UNSPSC 13.2	31261501
UNSPSC 18.0	31261501
UNSPSC 19.0	31261501
UNSPSC 20.0	31261501
UNSPSC 21.0	31261501

Approvals

Approvals

Approvals

EAC / DNV GL

Ex Approvals

Approval details

EAC		RU C- DE.AI30.B.01102
-----	--	--------------------------

DNV GL		https://approvalfinder.dnvgl.com/	TAE000037S
--------	--	---	------------

Housing - HC-ADV-B06-HHWH-1SGM25-PL - 1404226

Accessories

Accessories

Device marking

Snap-in markers - US-EMP (20X9) - 0829439



Snap-in markers, Card, white, unlabeled, can be labeled with: BLUEMARK ID COLOR, BLUEMARK ID, THERMOMARK PRIME, THERMOMARK CARD 2.0, THERMOMARK CARD, mounting type: snapped into marker carrier, lettering field size: 20 x 9 mm, Number of individual labels: 70

Mounting material

Screw - HC-B-TMS-ERSSCHR-IMB - 1409244



Replacement locking screw, M6, stainless steel, for HEAVYCON-ADVANCE housing, HC-B...TMS...EEE design, 5 mm Allen screw

Panel mounting flange

Mounting flange - HC-B-AF - 1686533



Panel mounting flange for HEAVYCON-ADVANCE TMS housing with screw locking

Mounting flange - HC-B-AF-SET - 1604638



Panel mounting flange for screw locking, set comprising 2 panel mounting flanges with 4 self-tapping screws (M4, Torx[®]) and 4 fan-type washers

Screwdriver tools

Housing - HC-ADV-B06-HHWH-1SGM25-PL - 1404226

Accessories

Screwdriver - SF-M BH - 1212070



Bit screwdriver, with 1/4" quick-action chuck, handle length 119 mm, 2-component handle, with non-slip grip, suitable for bits according to DIN 3126-C 6.3 and E 6.3/ISO 1173, magnetic

Screwdriver - SF-BIT-HEXB 5-89 - 1208911



Screw bit, hexagonal with ball head, E6.3-1/4" drive, size: Hex 5 x 89 mm, hardened, suitable for holder according to DIN 3126-F 6.3/ISO 1173